

K&F PLM+ SERIES

manufactured by
LAB.GRUPPEN

Powered Loudspeaker Management™ System

K&F PLM 20K44
K&F PLM 12K44
K&F PLM 5K44

Incorporating technologies from

lake



Quick Start Guide

Rev. 3.0.4
Released: 08.03.2018



Important Information, Please Read Before Use!

KLING & FREITAG GmbH
Junkersstrasse 14
D-30179 Hannover
TEL +49 (0) 511- 96 99 70
FAX +49 (0) 511- 67 37 94
www.kling-freitag.de

KLING &
FREITAG

SOUND SYSTEMS

1. Important safety instructions

Before using the device, be sure to carefully read the Safety Instructions. Keep this document with the device at all times.

1. Read these instructions.
2. Keep these instructions
3. Heed all warnings.
4. Follow all instructions.
5. Do not use this apparatus near water.
6. Clean only with a dry cloth.
7. Do not block any ventilation openings. Install in accordance with the manufacturer's instructions.
8. Do not install near any heat sources such as radiators, heat registers, stoves, or other apparatus (including amplifiers) that produce heat.
9. Do not defeat the safety purpose of the polarized or grounding-type plug. A polarized plug has two blades with one wider than the other. A grounding-type plug has two blades and a third grounding prong. The wide blade or the third prong is provided for your safety. If the provided plug does not fit into your outlet, consult an electrician for replacement of the obsolete outlet.
10. Protect the power cord from being walked on or pinched, particularly at plugs, convenience receptacles, and the point where they exit from the apparatus.
11. Only use attachments/accessories specified by the manufacturer.
12. Use only with a cart, stand, tripod, bracket, or table specified by the manufacturer, or sold with the apparatus. When a cart is used, use caution when moving the cart/apparatus combination to avoid injury from tip-over.
13. Unplug this apparatus during lightning storms or when unused for long periods of time.
14. Refer all servicing to qualified service personnel. Servicing is required when the apparatus has been damaged in any way, such as power-supply cord or plug is damaged, liquid has been spilled or objects have fallen into the apparatus, the apparatus has been exposed to rain or moisture, does not operate normally, or has been dropped.
15. Use the mains plug to disconnect the apparatus from the mains.
16. **WARNING:** To reduce the risk of fire or electric shock, do not expose this apparatus to rain or moisture.
17. Do not expose this equipment to dripping or splashing and ensure that no objects filled with liquids, such as vases, are placed on the equipment.
18. The mains plug of the power supply cord shall remain readily operable.
19. Do not connect the unit's output to any other voltage source such as battery, mains source, or power supply, regardless of whether the unit is turned on or off.
20. Do not remove the top (or bottom) cover. Removal of the cover will expose hazardous voltages. There are no user serviceable parts inside and removal may void the warranty.
21. An experienced user shall always supervise this professional audio equipment, especially if inexperienced adults or minors are using the equipment.
22. The US National Differences clause 16.3 requires that network cables must be flame rated VW-1.

2. Approvals



This equipment conforms to the requirements of the EMC Directive 2014/30/EU and the requirements of the Low Voltage Directive 2014/35/EU.

Standards applied: EMC Emission EN55032, Class A, EN55103-1, E4. EMC Immunity EN55103-2, E4, with S/N below 1% at normal operation level. Electrical Safety EN60065, Class I



This equipment is tested and listed according to the U.S. safety standard ANSI/UL 60065 and Canadian safety standard CSA C22.2 NO. 60065. Intertek made the tests and they are a Nationally Recognized Testing Laboratory (NRTL).

3. Warnings

3.1. Explanation of warning symbols



The lightning bolt triangle is used to alert the user to the presence of un-insulated "dangerous voltages" within the unit's chassis that may be of sufficient magnitude to constitute a risk of electric shock to humans.



The exclamation point triangle is used to alert the user to presence of important operating and service instructions in the literature accompanying the product.

3.2. Warnings

To prevent electric shock do not remove top or bottom covers. No user serviceable parts inside, refer servicing to qualified service personnel.

Français: À prévenir le choc électrique n'enlevez pas les couvercles. Il n'y a pas des parties serviceable à l'intérieur, tous reparations doit être faire par personnel qualifié seulement.





3. Warnings

 To completely disconnect this equipment from the AC mains, disconnect the power supply cord plug from the AC receptacle. The mains plug of the power supply cord shall remain readily operable.
Français: Pour démonter complètement l'équipement de l'alimentation générale, démonter le câble d'alimentation de son réceptacle. La prise d'alimentation restera aisément fonctionnelle.

 To reduce risk of fire or electric shock, do not expose this apparatus to rain or moisture.
Français: Pour réduire les risques d'incendie ou de choc électrique, n'exposez pas l'appareil à la pluie ou à l'humidité.

 Do not expose this system/apparatus to dripping or splashing and ensure that no objects filled with liquids, such as vases, are placed on the apparatus.
Français: N'exposez pas ce système/appareil au ruissellement ni aux éclaboussures et assurez-vous qu'aucun objet contenant du liquide tel qu'un vase n'est placé sur l'appareil.

 This apparatus must be connected to a mains socket outlet with a protective earthing connection.
Français: Cet appareil doit être raccordé à une prise secteur avec terre de protection.

 The mains plug is used as a disconnect device and shall remain readily operable.
Français: Lorsque la prise du réseau d'alimentation est utilisée comme dispositif de déconnexion, ce dispositif doit demeurer aisément accessible.

3.3. Caution

 To reduce the risk of fire or electric shock, do not remove screws. No user-serviceable parts inside. Refer servicing to qualified service personnel.
Français: Pour réduire le risque d'incendie ou de choc électrique, ne pas retirer les vis. Aucune pièce réparable par l'utilisateur. Confier l'entretien à personnel qualifié.

3.4. User responsibility

3.4.1. Mains connection grounding

Your amplifier must be connected to a grounded socket outlet.

3.4.2. Speaker output hazard on amplifiers

Amplifiers are capable of producing hazardous output voltages. To avoid electrical shock, do not touch any exposed speaker wiring while the amplifier is operating. The external wiring connected to the speaker terminals shall be installed by a qualified person, or ready-made leads or cords of appropriate capacity shall be used.

As the power output channels on amplifiers produce high voltage, do not connect or disconnect speaker cables when the mains power is on.

3.4.3. Radio interference

A sample of this product has been tested and complies with the limits for the European Electro Magnetic Compatibility (EMC) directive. This equipment has also been tested and found to comply with the limits for a Class A digital device, pursuant to Part 15 of the FCC Rules. These limits are designed to provide reasonable protection against harmful interference from electrical equipment. This product uses radio frequency energy and if not used or installed in accordance with these operating instructions, may cause interference to other equipment, such as radio receivers.

This Class A digital apparatus complies with Canadian ICES-003.
Cet appareil numérique de la classe A est conforme à la norme NMB-003 du Canada.

However, there is no guarantee that interference will not occur in a particular installation. If this equipment does cause harmful interference to radio or television reception, which can be determined by turning the equipment on and off, the user is encouraged to try to correct the interference by one or more of the following measures:

- Reorient or relocate the antenna.
- Increase the separation between the equipment and receiver.
- Connect the equipment to an outlet on a circuit different from that to which the receiver is connected.
- Check if the affected unit complies with the EMC limits for immunity, (CE-labeled). If not, address the problem with the manufacturer or supplier. All electrical products sold in the EC must be approved for immunity against electromagnetic fields, high voltage flashes, and radio interference.
- Consult the dealer or an experienced radio/TV technician for help.

3.4.4. Speaker damage

Amplifier apparatus is very powerful and can be potentially dangerous to both loudspeakers and humans alike. Many loudspeakers can be easily damaged or destroyed by overpowering them. Always check the speaker's continuous and peak power capabilities. Although the amplifiers attenuators can be used to reduce the overall gain, an increase of the input signal can result in full output power, which may cause damage to connected speakers.

3.4.5. Maintenance

For safe and reliable operation, the dust filters on both sides of the front panel, behind the grilles, should be removed and cleaned regularly to ensure maximum airflow through the device.

If the dust filters are not maintained there will be safety risks; for example, high internal temperatures could ignite the dust and start a fire. There is also a risk that the unit will malfunction since it is dependent on constant airflow from front to rear. If the dust filters are not clean and the unit malfunctions, any resulting problems will not be covered by the warranty.

1.重要的安全说明

在使用设备之前，请确保仔细阅读了安全说明，并始终将本安全说明手册和设备一同保管。

1. 仔细阅读本说明。
2. 保管好本说明。
3. 注意所有的警告事项。
4. 按照所有说明进行操作。
5. 切勿在靠近水的地方使用此设备。
6. 只能用于布进行清洁擦拭。
7. 切勿堵塞任何通风口。严格按照生产商的说明来安装。
8. 切勿在靠近热源的地方安装，比如散热器、热风口、火炉或其他产生热量的设备（包括功率放大器）。
9. 请勿破坏极化插头或接地型插头的安全作用。极化插头有两个引脚，其中一个稍宽。接地型插头有两个引脚和另一个接地端。极化插头的较宽引脚或接地型插头的接地端可为您提供安全保护。如果提供的插头不适合您的电源插座，请向电气技师咨询以更换过时的插座。
10. 防止电源线被踩到或受到挤压，特别是在插头、电源插座以及与设备的连接点等处。
11. 仅使用生产商指定的附件/配件。
12. 仅使用生产商指定或者随设备一起出售的手推车、支架、三脚架、托架或工作台。如果使用手推车，在移动装有设备的手推车时必须多加小心以防止翻倒造成人员受伤。
13. 在雷雨期间或长期不使用设备时，拔出此设备电源插头。
14. 仅向合格的维修人员寻求各项服务。无论设备受到何种形式的损坏都应该进行维修，例如电源线或插头受损、设备溅水或有物体掉入设备中、设备淋雨或受潮、设备工作不正常或不慎摔落到地上。
15. 需要完全断开此设备与交流市电的连接，请把电源线插头从交流电插座中拔出。
16. 警告：为了减少发生火灾或触电的风险，请勿将此设备暴露在雨中或潮湿环境中。
17. 不要将设备放置在容易遭受液体滴溅或者喷洒的地方，不要将盛有液体的物品（如花瓶）放在此设备上。
18. 电源线插头应保持随时可用的状态。
19. 请勿将设备的输出与任何具有电压输出的装置连接，比如电池、交流市电电源或其他电源变压器。在进行任何连接的时候，都需要注意确认设备处于关闭状态。
20. 请勿移除设备顶部（或底部）的机壳，擅自拆开设备外壳会导致电击的风险。设备内部没有用户可自行维护的部件。擅自拆开设备外壳会导致失去保修服务。
21. 此设备是专业音频产品，需要用户具有相关的操作经验，新手或对本设备不了解的用户使用时，需要有经验丰富的用户在场监督。
22. 根据美国国家差异条款16.3，要求使用的网络线缆，必须符合VW-1级别的阻燃要求。

2. 认证



该设备遵循 EMC 条例 2014/30/EU 和低电压条例 2006/95/EC。

符合以下标准：

EMC 抗辐射 EN55032, Class A, EN55103-1, E4.
EMC 抗干扰性 EN55103-2, E4, 以及正常操作时 S/N 低于 1%
电气安全 EN60065, Class I



该设备根据美国安全标准 ANSI/UL 60065 和加拿大安全标准 CSA C22.2 NO. 600065 进行测试和认证。Intertek 作为测试机构，他们是一个国际认可的测试实验室（NRTL）。

3. 警告

3.1. 对图形符号的说明



带箭头的闪电三角形符号是警告用户设备内部存在未绝缘的危险电压，可能会足够导致触电的危险。



感叹号三角形是提醒用户设备附带的手册中具有重要的操作和维护说明。

3.2. 警告

为了避免发生电击的风险，请勿打开设备顶部或底部的机壳。设备内部没有用户可以自行维护的部件。请仅向合格的维修人员寻求各项服务。

Français: À prévenir le choc électrique n'enlevez pas les couvercles. Il n'y a pas des parties serviceable à l'intérieur, tous reparations doit être faire par personnel qualifié seulement.



3. 警告

 需要完全断开此设备与交流市电的连接，请把电源线插头从交流电插座中拔出。电源线插头应保持随时可用的状态。

Français: Pour démonter complètement l'équipement de l'alimentation générale, démonter le câble d'alimentation de son réceptacle. La prise d'alimentation restera aisément fonctionnelle.

 为了减少发生火灾或触电的风险，请勿将此设备暴露在雨中或潮湿的环境中。

Français: Pour réduire les risques d'incendie ou de choc électrique, n'exposez pas l'appareil à la pluie ou à l'humidité.

 不要将设备放置在容易遭受液体滴溅或喷洒的地方，不要将盛有液体的物品（如花瓶）放在此设备上。

Français: N'exposez pas ce système/appareil au ruissellement ni aux éclaboussures et assurez-vous qu'aucun objet contenant du liquide tel qu'un vase n'est placé sur l'appareil.

 此设备必须连接到带有保护性接地的市电插座上。

Français: Cet appareil doit être raccordé à une prise secteur avec terre de protection.

 电源插头用作断开此设备和交流市电的连接，并且保持随时可用的状态。

Français: Lorsque la prise du réseau d'alimentation est utilisée comme dispositif de déconnexion, ce dispositif doit demeurer aisément accessible.

3.3. 注意

 为了避免发生电击的风险，请勿移除外壳上的螺丝。设备内部没有用户可以自行维护的部件。请仅向合格的维修人员寻求各项服务。

Français: Pour réduire le risque d'incendie ou de choc électrique, ne pas retirer les vis. Aucune pièce réparable par l'utilisateur. Confier l'entretien à personnel qualifié.

3.4. 用户责任

3.4.1. 电源插头接地

您购买的功放设备，必须连接到带有保护性安全接地的市电插座上。

3.4.2. 注意功放设备扬声器输出的危险

功放设备扬声器输出的电压可能导致危险。为了避免电击风险，操作功放设备时请勿触摸任何扬声器线。连接功放到扬声器端子的外部接线工作应当由有资格的专业人员进行安装。请使用符合规格的成品扬声器线或选用足够线径的扬声器线。

当功放设备工作时，扬声器输出通道存在高电压，不要在设备电源接通时连接或断开扬声器线。

3.4.3. 无线电干扰

此设备的样品已经通过测试，符合欧洲电磁兼容性 (EMC) 的规定限制。此设备也进行了测试，并证明符合根据 FCC 规则第 15 章的 A 类数字设备限制条例。这些限制旨在提供合理的保护，避免电气设备产生有害的无线电干扰。本产品使用的无线电频率能量，如果不按照这些操作说明使用或安装，可能会干扰其他设备的正常使用，比如无线电接收机。

这个 A 类数字设备符合加拿大 ICES-003 标准。

Cet appareil numérique de la classe A est conforme à la norme NMB-003 du Canada.

无论如何，在某些特定的安装情况下，无法保证干扰不会发生。如果此设备确实干扰无线电或电视机的接收，可通过开启或关闭此设备进行判断，用户可尝试通过以下一种或多种措施来消除干扰：

- 重新定位或移动天线的位置。
- 增加此设备和接收器之间的距离。
- 将此设备连接到与无线电接收设备不同的交流电源上的电源插座。
- 检查受影响设备是否符合 EMC 抗干扰标准（有 CE 标记）。如果不是，请联系设备的制造厂商或供应商。所有在欧盟销售的电气产品必须通过电磁场抗扰，高电压击穿和无线电干扰检测。
- 咨询经销商或有经验的无线电/电视技术人员以寻求帮助。

3.4.4. 扬声器损坏

功放设备的输出功率是十分强大的，可能会对扬声器和人体都造成伤害。许多扬声器在超出功率之后很容易故障或破坏。请务必检查扬声器的额定和峰值功率是否符合要求。

虽然功放设备的衰减器可以用来减小整体的增益，但一个突然增大的输入信号依然会导致功放输出最大的功率，并导致连接的扬声器损坏。

3.4.5. 设备维护

为了设备可以安全可靠的运行，前面板两侧可拆卸栅格背后的灰尘滤网，需定期拆下并清洗，以确保最大的散热气流通过设备。

如果灰尘滤网不进行清洗维护，会造成安全隐患；例如，内部的高温可能会引燃灰尘造成设备起火。并且可能造成散热装置故障的风险，因为此设备依赖持续不断的由前至后的气流保证散热。如果灰尘滤网不干净或者散热装置故障，由此产生的任何问题，将不在保修范围内。

1. 安全に関する注意事項

本装置を使用する前に、必ず安全のための注意事項をご一読ください。この書類は、常に装置と一緒に保管してください。

1. 注意事項をお読みください。
2. 注意事項の書類は手の届くところに保管しておいてください。
3. 全ての警告をお守りください。
4. 全ての指示に従ってください。
5. 本機器は水の近くで使用しないでください。
6. 掃除には、乾いた布のみを使用してください。
7. 換気口は塞がないようにしてください。製造者の指示に従って設置してください。
8. ラジエーター、暖房送風口、ストーブをはじめ、熱を発生する機器（アンプを含む）の近くに設置しないでください。
9. 有極プラグや接地極付きプラグは安全性を確保するための構造です。無効にしないでください。有極プラグは、二本の差し込み刃のうち、一方が幅広になっています。接地極付きプラグは、二本の差し込み刃と、一本の接地極が付いています。幅広の差し込み刃や接地極は、使用者の安全を守るためのものです。製品に付属するプラグがコンセントの差し込み口に合わない場合は、電気工事業者に相談し、古いコンセントを新しいものと交換してください。
10. 電源コードは、特に差し込み部分、延長コード、機器から出ている部分において、人に踏まれたりはさまれたりしないように保護してください。
11. アクセサリーや装着器具は、メーカー指定のもののみをご使用ください。
12. カート、スタンド、三脚、ブラケット、テーブルは、付属品または製造者が指定するもののみを使用してください。カートを使用する場合は、カートと機器を移動する際の転倒や落下による怪我にご注意ください。
13. 雷雨の発生中または長期間使用しない場合は、プラグをコンセントから抜いてください。
14. サービス作業は、必ず資格のあるサービス作業担当者が実施してください。サービス作業は、電源コードやプラグの損傷、機器に液体がかかったまたは異物が入り込んだ場合、機器が雨や湿気にさらされた場合、正常に動作しない場合、機器を落とした場合など、機器が何らかの状態に損傷した際に必要です。
15. 機器と電源の接続を完全に遮断するには、電源プラグをコンセントから抜いてください。
16. 警告：火事や感電のリスクを軽減するため、機器を雨や湿度にさらさないでください。
17. 機器に水が垂れるまたは液体が飛散する環境では使用しないでください。花瓶など液体の入ったものを機器の上に置かないでください。
18. 電源コードの電源プラグは常に容易に抜き差しできるようにしてください。
19. 本装置のオン/オフの状態に関わらず、本装置の出力は、バッテリー、商用電源、パワーサプライ等のいかなる電源にも接続しないでください。
20. 上面または底面のカバーを取り外さないでください。カバーを取り外すと、危険な電圧を持った部品が露出します。内部にユーザ保守可能な部品はございません。カバーを取り外すと、保証が無効になることがあります。
21. 本業務用音響機器は、成人・未成人に関わらず未経験者が使用する場合は特に、必ず経験者の監視の元で使用してください。

22. ネットワーク・ケーブルを使用する場合、US National Differences 16.3 項は、VW-1 の難燃対応品を使用することを義務づけています。

2. 規格



本機器は、EMC (European Electro-Magnetic Compatibility: EU 電磁両立性) 指令 2014/30/EU および低電圧指令 2014/35/EU の必須要求事項に準拠しています。

適用規格: EMC エミッションに関する規制 EN55032, Class A, EN55103, E4.
EMC イミュニティに関する規制 EN55103-2, E4 (通常運用レベルにおいて、S/N 比 1 % 未満)。
機器の安全規格 EN60065, クラス I。



本機器は、米国安全規格 ANSI/UL 60065 およびカナダ安全規格 CSA C22.2 NO. 60065 に基づいてテストされ、承認されています。テストは、NRTL (Nationally Recognized Testing Laboratory: 国家認定試験機関) として認定されている Intertek によって実施されています。

3. 警告

3.1 本書で使用する記号



三角形に括られた矢印付きの落雷マークは、接触すると感電の危険性がある、危険な高電圧が絶縁されていない部品が機器内部に配置されていることを示します。



三角形に括られた「!」サインは、機器を使用またはサービス作業を実施するうえで重要となる情報が、製品に付属の文書類に記載されていることを示します。

3.2 警告事項

感電の危険性があるため、上面または底面のカバーは取り外さないでください。機器内部には、ユーザーがサービス作業を実施できる部品はありません。サービス作業は、必ず資格のあるサービス作業担当者が実施してください。
Français: À prévenir le choc électrique n'enlevez pas les couvercles. Il n'y a pas des parties serviceable à l'intérieur, tous reparations doit être faire par personnel qualifié seulement.





 機器を電源から完全に遮断するには、電源プラグをコンセントから抜いてください。電源ケーブルの電源プラグは常に容易に抜き差しできるようにしてください。

Français: Pour démonter complètement l'équipement de l'alimentation générale, démonter le câble d'alimentation de son réceptacle. La prise d'alimentation restera aisément fonctionnelle.

 火災や感電の危険性をなくすために、機器を雨や湿気にさらさないでください。
Français: Pour réduire les risques d'incendie ou de choc électrique, n'exposez pas l'appareil à la pluie ou à l'humidité.

 本システム／機器は、水が垂れるまたは液体が飛散する環境では使用しないでください。花瓶など液体の入ったものを機器の上に置かないでください。
Français: N'exposez pas ce système/appareil au ruissellement ni aux éclaboussures et assurez-vous qu'aucun objet contenant du liquide tel qu'un vase n'est placé sur l'appareil.

 本機器は、必ず保護用アース接続（接地）を備えたコンセントに接続してください。
Français: Cet appareil doit être raccordé à une prise secteur avec terre de protection.

 電源プラグは、電源との絶縁のための機構です。常に容易に抜き差しできるようにしてください。
Français: Lorsque la prise du réseau d'alimentation est utilisés comme dispositif de déconnexion, ce dispositif doit demeuré aisément accessible.

3.3 注意事項

 火事や感電のリスクを軽減するため、本装置のネジは外さないでください。内部にユーザ保守可能な部品はございません。修理点検は有資格者にのみ依頼してください。
Français: Pour réduire le risque d'incendie ou de choc électrique, ne pas retirer les vis. Aucune pièce réparable par l'utilisateur. Confier l'entretien à personnel qualifié.

3.4 使用者責任

3.4.1 接続電源の接地

装置（アンプリファイアー）は必ず接地されたコンセントに接続してください。

3.4.2 アンプリファイアーのスピーカー出力の危険性

アンプリファイアーは危険な電圧を出力する能力を持ちます。感電を避けるため、アンプ稼働中に露出されたスピーカーのワイアリングには触れないでください。スピーカー・ターミナルに接続する外部配線の設置は必ず有資格者が行うか、既製品を使用する場合には必ず適切な容量の線を使用してください。

アンプの出力チャンネルは高電圧を生成します。電源がオンの場合は絶対にスピーカー・ケーブルの抜き差しを行わないでください。

3.4.3 電波障害

本装置のサンプルは European Electro Magnetic Compatibility (EMC) directive の制限事項に適合するための試験に合格しています。また、本装置は FCC 基準 Part 15 に準ずる Class B デジタル機器の制限事項に適合するための試験に合格しています。これらの制限事項は、装置の設置に伴って生じる有害な電波障害からの適切な保護を目的に制定されたものです。本装置は無線周波エネルギーを使用しており、取扱説明書の指示に従った設置と使用を行わないと、無線受信機等の機器に障害を及ぼす可能性があります。

This Class A digital apparatus complies with Canadian ICES-003. 本 Class A デジタル装置は、カナダ ICES-003 に準拠しています。Cet appareil numérique de la classe A est conforme à la norme NMB-003 du Canada.

しかしながら、特定の設置状況において電波干渉を起こさないという保証はありません。本機器がラジオやテレビの受信に障害を与えていないかを判断するには、本機器の電源を立ち下げてから再度立ち上げてください。障害を及ぼすことがわかった場合、次の方法で干渉の解消を試みることを推奨します。

- 受信アンテナの方向、設置場所を変更する
- 本装置と受信機の距離を遠ざける
- 本装置を受信機とは別の系統の電源回路に接続する
- 影響を受けている装置が EMC 耐性の制限事項に準拠していることをご確認ください（CE ラベル）。準拠していない場合は、その装置の製造者または供給者に問題を通知してください。EC 内で販売される全ての電気製品は電磁界、高電圧フラッシュ、電波障害に対する耐性の認可を受ける必要があります。
- 販売店、あるいはラジオ／テレビ技師にご相談ください。

3.4.4 スピーカーの破損

アンプリファイアー機器は大変強力で、スピーカーと人間に危険を及ぼす能力と可能性を持ちます。多くのスピーカーは、過大入力が生じると容易に破損または破壊されます。常にスピーカーの連続ならびにピーク・パワー容量をご確認ください。アンプリファイアーのアッテネーターで全体のゲインを下げることはできますが、入力信号のレベル増加がフル出力パワーを招き、接続先のスピーカーを破損することがあります。

3.4.5 メンテナンス

安全で信頼性の高い動作を維持するために、定期的にフロントパネル両側、グリル裏のダスト・フィルターを取り外して清掃することで最大限の換気が行えるようにしてください。

ダスト・フィルターのメンテナンスを怠ると安全面でのリスクが生じます。例えば、内部温度の上昇により埃が発火する可能性があります。また、装置は安定した前面吸気／背面排気の換気が行えることを前提としているため、故障のリスクが生じます。ダスト・フィルターがきれいでない状態に起因する本体の異常が生じても、結果的な問題は保証外となります。

1. Instructions de sécurité importantes

Avant d'utiliser l'appareil, veuillez à lire attentivement les instructions de sécurité. Conservez constamment ce document avec l'appareil.

1. Lisez ces instructions.
2. Conservez ces instructions.
3. Tenez compte de tous les avertissements.
4. Suivez toutes les instructions.
5. N'utilisez pas cet appareil avec de l'eau à proximité.
6. Ne nettoyez l'appareil qu'avec un chiffon sec.
7. N'obstruez aucune ouverture de ventilation. Installez l'unité conformément aux instructions du fabricant.
8. Ne l'installez pas à proximité de sources de chaleur telles que des radiateurs, bouches de chaleur, poêles ou autres appareils (y compris des amplificateurs) qui dégagent de la chaleur.
9. Ne neutralisez pas la fonction de sécurité de la fiche polarisée ou de terre. Une fiche polarisée a deux broches, l'une plus large que l'autre. Une fiche de terre a deux broches identiques et une troisième broche pour la mise à la terre. La broche plus large ou la troisième broche servent à votre sécurité. Si la fiche fournie n'entre pas dans votre prise, consultez un électricien pour le remplacement de la prise obsolète.
10. Évitez de marcher sur le cordon d'alimentation et de le pincer, en particulier au niveau des fiches, des prises secteur, et du point de sortie de l'appareil.
11. N'utilisez que des fixations/accessoires spécifiés par le fabricant.
12. Utilisez-le uniquement avec un chariot, socle, trépied, support ou table spécifié par le fabricant ou vendu avec l'appareil. Si un chariot est utilisé, faites attention à ne pas être blessé par un renversement lors du déplacement de l'ensemble chariot/appareil.
13. Débranchez cet appareil en cas d'orage ou de non utilisation prolongée.
14. Confiez toute réparation à des techniciens de maintenance qualifiés. Une réparation est nécessaire si l'appareil a été endommagé d'une quelconque façon, par exemple si le cordon ou la fiche d'alimentation est endommagé, si du liquide a été renversé sur l'appareil ou si des objets sont tombés dedans, si l'appareil a été exposé à la pluie ou à l'humidité, s'il ne fonctionne pas normalement, ou s'il est tombé.
15. Utilisez la fiche d'alimentation électrique pour débrancher l'appareil du secteur.
16. **AVERTISSEMENT** : pour réduire le risque d'incendie et de choc électrique, n'exposez pas cet appareil à la pluie ni à l'humidité.
17. N'exposez pas cet appareil au ruissellement ni aux éclaboussures et n'y posez pas d'objets remplis de liquide comme par exemple des vases.
18. La fiche secteur du cordon d'alimentation doit toujours rester facilement accessible.
19. Ne branchez pas la sortie de l'unité à une autre source de tension telle qu'une batterie, une prise secteur ou une alimentation électrique, que l'unité soit ou non allumée.
20. Ne retirez pas le capot du dessus (ou du dessous). Retirer le capot exposera à l'air libre des tensions dangereuses. Aucune pièce n'est réparable par l'utilisateur à l'intérieur et l'ouverture peut invalider la garantie.
21. Un utilisateur chevronné doit toujours superviser cet équipement audio professionnel, particulièrement si des adultes inexpérimentés ou des mineurs utilisent l'équipement.
22. Aux USA, la clause 16.3 des US National Differences exige une classe d'inflammabilité VW-1 pour les câbles réseau.



2. Certifications



Cet équipement se conforme aux spécifications de la directive CEM sur la compatibilité électromagnétique 2014/30/EU et de la directive basse tension 2014/35/EU.

Normes appliquées :
Émission CEM EN55032, Class A, EN55103, E4.
Immunité CEM EN55103-2, E4, avec rapport signal/bruit < 1 % au niveau de fonctionnement normal.
Sécurité électrique EN60065, Classe I



Cet équipement a été testé et référencé à la norme de sécurité ANSI/UL 60065 pour les USA et CSA C22.2 N° 60065 pour le Canada. Les tests ont été effectués par Intertek, un laboratoire de test à agrément national (NRTL).

3. Avertissements

3.1. Explication des symboles d'avertissement



Le symbole d'éclair à tête de flèche dans un triangle équilatéral sert à prévenir l'utilisateur de la présence dans l'enceinte du produit d'une « tension dangereuse » non isolée suffisante pour constituer un risque d'électrocution pour les personnes.



Le point d'exclamation dans un triangle équilatéral sert à prévenir l'utilisateur de la présence d'instructions importantes de fonctionnement et de maintenance (entretien) dans les documents accompagnant l'appareil.

3.2. Avertissements

Pour éviter les chocs électriques, ne retirez pas les capots du dessus et du dessous. Aucune pièce interne n'est réparable par l'utilisateur, confiez toute réparation à des techniciens de maintenance qualifiés.



3. Avertissements

 Pour totalement isoler l'équipement de l'alimentation secteur, débranchez le cordon d'alimentation de son embase. La fiche secteur du cordon d'alimentation doit rester accessible.

 Pour réduire les risques d'incendie et de choc électrique, n'exposez pas cet appareil à la pluie ou à l'humidité.

 N'exposez pas ce système/appareil au ruissellement ni aux éclaboussures et assurez-vous qu'aucun objet contenant du liquide, tel qu'un vase, n'est placé sur l'appareil.

 Cet appareil doit être raccordé à une prise secteur avec terre de protection.

 La fiche d'alimentation sert de dispositif de déconnexion et doit rester constamment accessible.

3.3. Attention

 Pour réduire le risque d'incendie et de choc électrique, ne retirez pas les vis. Aucune pièce interne n'est réparable par l'utilisateur. Confiez toute réparation à des techniciens de maintenance qualifiés.

3.4. Responsabilité de l'utilisateur

3.4.1. Mise à la terre de la prise secteur

Votre amplificateur doit être connecté à une prise de terre.

3.4.2. Danger aux sorties pour enceintes des amplificateurs

Les amplificateurs sont capables de produire des tensions de sortie dangereuses. Pour éviter tout choc électrique, ne touchez aucun fil d'enceinte ni quand l'amplificateur est en service. Le câble externe connecté aux borniers d'enceintes doit être préparé par une personne qualifiée, sinon des cordons tout prêts de capacité appropriée doivent être utilisés.

Comme les canaux de sortie de puissance des amplificateurs produisent une tension élevée, les câbles d'enceintes ne doivent pas être branchés ou débranchés quand l'appareil est sous tension.

3.4.3. Interférences radioélectriques

Un échantillon de ce produit a été testé et déclaré conforme aux limites fixées par la Directive européenne sur la compatibilité électromagnétique (CEM). Cet équipement a aussi été testé et trouvé conforme aux limites fixées pour un appareil numérique de Classe A par la partie 15 de la réglementation FCC. Ces limites sont conçues pour assurer une protection raisonnable contre les interférences nuisibles causées par des appareils électriques. Ce produit utilise des ondes radioélectriques et, s'il n'est pas installé et utilisé conformément à ces instructions d'utilisation, peut causer des interférences avec d'autres appareils, tels que les radiorécepteurs.

This Class A digital apparatus complies with Canadian ICES-003.
Cet appareil numérique de la classe A est conforme à la norme NMB-003 du Canada.

L'absence d'interférences n'est toutefois pas garantie pour une installation donnée. Si cet équipement provoque des interférences nuisibles à la réception de la radio ou de la télévision, ce qui peut être déterminé en allumant et en éteignant l'équipement, l'utilisateur est encouragé à essayer de corriger les interférences en prenant une ou plusieurs des mesures suivantes :

- Réorienter ou déplacer l'antenne.
- Augmenter l'espace séparant l'équipement du récepteur.
- Brancher l'équipement à une prise d'un circuit différent de celui auquel est branché le récepteur.
- Vérifier si l'unité concernée est conforme aux limites de CEM pour l'immunité (étiquetage CE). Sinon, résolvez le problème avec le fabricant ou le fournisseur. Tous les produits électriques vendus en UE doivent avoir une immunité certifiée contre les champs électromagnétiques, les surtensions, et les interférences radioélectriques.
- Consulter le revendeur ou un technicien radio/TV expérimenté pour obtenir de l'aide.

3.4.4. Dommages causés aux enceintes

Un amplificateur est très puissant et peut être potentiellement dangereux à la fois pour les enceintes et pour les êtres humains. De nombreuses enceintes peuvent être facilement endommagées ou détruites si on les soumet à une puissance excessive. Vérifiez toujours les puissances admissibles par l'enceinte, en continu et en crête. Bien que des atténuateurs d'amplificateurs puissent être utilisés pour réduire le gain général, une augmentation du signal d'entrée peut conduire à une sortie à pleine puissance risquant d'endommager les enceintes connectées.

3.4.5. Entretien

Pour un fonctionnement sûr et fiable, les filtres à poussière, des deux côtés de la face avant derrière les grilles, doivent être retirés et nettoyés régulièrement afin d'assurer une circulation maximale de l'air au travers de l'appareil.

Ne pas entretenir les filtres à poussière entraîne des risques pour la sécurité ; par exemple, une surchauffe interne peut amener la poussière à s'enflammer, déclenchant un incendie. Il existe également un risque de mauvais fonctionnement de l'unité car celle-ci nécessite un débit d'air constant de l'avant vers l'arrière. Si les filtres à poussière ne sont pas propres et si l'appareil ne fonctionne pas correctement, les problèmes qui en résultent ne sont pas couverts par la garantie.

1. Wichtige Sicherheitshinweise

Lesen Sie bitte diese Sicherheitsanweisungen sorgfältig, bevor Sie das Gerät verwenden. Bewahren Sie dieses Dokument bitte jederzeit zusammen mit dem Gerät auf.

1. Bitte lesen Sie diese Anweisungen.
2. Bitte bewahren Sie diese Anweisungen auf.
3. Beachten Sie alle Warnhinweise.
4. Folgen Sie bitte allen Anweisungen.
5. Verwenden Sie dieses Gerät nicht in der Nähe von Wasser.
6. Reinigen Sie das Gerät nur mit einem trockenen Tuch.
7. Die Belüftungsöffnungen des Gerätes dürfen nicht verdeckt werden. Folgen Sie bitte bei der Montage des Gerätes allen Anweisungen des Herstellers.
8. Montieren Sie das Gerät nicht neben Hitzequellen wie Heizkörpern, Wärmespeichern, Öfen oder anderen Geräten (auch Leistungsverstärkern), die Hitze abstrahlen.
9. Nehmen Sie keine Veränderungen am Netzstecker dieses Gerätes vor. Ein polarisierter Stecker hat zwei Kontakte, von denen einer breiter ist als der andere. Ein geerdeter Stecker hat zwei Kontakte sowie einen dritten Erdungskontakt. Der breitere Kontakt beziehungsweise der Erdungskontakt dient Ihrer Sicherheit. Wenn der Stecker an dem mit diesem Gerät gelieferten Kabel nicht zur Steckdose am Einsatzort passt, lassen Sie die entsprechende Steckdose durch einen Elektriker ersetzen.
10. Sichern Sie das Netzkabel gegen Einquetschen oder Abknicken, insbesondere am Gerät selbst sowie an dessen Netzstecker.
11. Verwenden Sie nur vom Hersteller benannte Ergänzungen und Zubehörteile für dieses Gerät.
12. Verwenden Sie nur die vom Hersteller als geeignet angegebenen oder zusammen mit dem Gerät verkauften Gestelle, Podeste, Halteklammern oder Unterbauten für dieses Gerät. Wenn Sie einen Rollwagen verwenden, achten Sie darauf, dass das Gerät beim Bewegen gegen Herunterfallen gesichert ist, um das Verletzungsrisiko zu minimieren.
13. Trennen Sie das Gerät vom Stromnetz, wenn ein Gewitter aufkommt oder wenn Sie es voraussichtlich für längere Zeit nicht verwenden werden.
14. Alle Wartungsarbeiten müssen von hierfür qualifizierten Servicemitarbeitern durchgeführt werden. Eine Wartung ist erforderlich, wenn das Gerät selbst oder dessen Netzkabel beschädigt wurde, Flüssigkeiten oder Gegenstände in das Gerät gelangt sind, das Gerät Regen oder starker Feuchtigkeit ausgesetzt wurde, das Gerät nicht ordnungsgemäß arbeitet oder es heruntergefallen ist.
15. Verwenden Sie den Netzstecker, um das Gerät vom Stromnetz zu trennen.
16. **WARNUNG:** Um die Gefahr eines Feuers oder eines elektrischen Schlages zu verringern, darf dieses Gerät nicht Regen oder starker Feuchtigkeit ausgesetzt werden.
17. Setzen Sie dieses Gerät nicht tropfendem Wasser oder Spritzwasser aus. Stellen Sie keine mit Flüssigkeiten gefüllten Gegenstände – wie beispielsweise Vasen – auf diesem Gerät ab.
18. Der Netzstecker des Gerätes sollte jederzeit zugänglich sein.
19. Verbinden Sie den Ausgang des Gerätes weder in eingeschaltetem noch ausgeschaltetem Zustand mit anderen Spannungsquellen (beispielsweise Batterien, Netzanschlüssen oder Netzteilen).
20. Entfernen Sie nicht die obere oder untere Abdeckung des Gerätes. Wenn Sie die Abdeckung entfernen, werden Bauteile freigelegt, die gefährliche Spannungen führen. Es befinden sich keine vom Anwender zu wartenden Teile in diesem Gerät, und das Entfernen der Abdeckung kann zum Erlöschen der Garantie führen.
21. Die Bedienung dieses Gerätes sollte stets durch einen erfahrenen Anwender erfolgen oder von diesem überwacht werden. Dies gilt besonders dann, wenn nicht sachkundige Erwachsene oder Minderjährige das Gerät bedienen.
22. Entsprechend US National Differences Abschnitt 16.3 müssen Netzkabel flammwidrig nach WW-1 sein.

2. Kennzeichnungen



Dieses Gerät entspricht den Anforderungen der EMV-Richtlinie 2014/30/EU und den Anforderungen der Niederspannungsrichtlinie 2014/35/EU. Angewendete Standards: EMV EN55032, Class A, EN55103, E4. EMC Immunity EN55103-2, E4, mit S/N unter 1% bei normalem Betriebspegel. Sicherheitsnorm für elektronische Geräte EN60065, Class I



Dieses Gerät wurde gemäß dem US-Sicherheitsstandard ANSI/UL 60065 und der kanadischen Sicherheitsnorm CSA C22.2 Nr. 60065 geprüft und gelistet. Die Tests wurden von Intertek – einem Nationally Recognized Testing Laboratory (NRTL) – durchgeführt.

3. Warnungen

3.1. Erläuterung der Warnsymbole



Das Blitzsymbol weist den Anwender auf eine nicht isolierte Spannungsquelle im Gehäuse des Gerätes hin, die stark genug sein kann, um bei Anwendern einen Stromschlag auszulösen.



Ein Ausrufezeichen in einem Dreieck weist den Anwender auf wichtige Anweisungen zum Betrieb und Instandhaltung des Produkts in den begleitenden Unterlagen hin.

3.2. Warnungen

Um einen Stromschlag zu vermeiden, dürfen Sie die obere und untere Abdeckung des Gerätes nicht entfernen. Es befinden sich keine vom Anwender zu wartenden Teile in diesem Gerät, Wartungsarbeiten müssen von hierfür qualifizierten Servicemitarbeitern durchgeführt werden.

Français: À prévenir le choc électrique n'enlevez pas les couvercles. Il n'y a pas des parties serviceable à l'intérieur, tous reparations doit être faire par personnel qualifié seulement.





3. Warnungen

 Um das Gerät vollständig vom Stromnetz zu trennen, müssen Sie den Netzstecker des Gerätes aus der Steckdose ziehen. Der Netzstecker des Gerätes sollte jederzeit zugänglich sein.
Français: Pour démonter complètement l'équipement de l'alimentation générale, démonter le câble d'alimentation de son réceptacle. La prise d'alimentation restera aisément fonctionnelle.

 Um die Gefahr eines Feuers oder eines elektrischen Schlages zu verringern, darf dieses Gerät nicht Regen oder starker Feuchtigkeit ausgesetzt werden.
Français: Pour réduire les risques d'incendie ou de choc électrique, n'exposez pas l'appareil à la pluie ou à l'humidité.

 Setzen Sie dieses System/Gerät nicht tropfendem Wasser oder Spritzwasser aus. Stellen Sie keine mit Flüssigkeiten gefüllten Gegenstände – wie beispielsweise Vasen – auf diesem Gerät ab.
Français: N'exposez pas ce système/appareil au ruissellement ni aux éclaboussures et assurez-vous qu'aucun objet contenant du liquide tel qu'un vase n'est placé sur l'appareil.

 Dieses Gerät muss an eine Steckdose mit Schutzleiter angeschlossen werden.
Français: Cet appareil doit être raccordé à une prise secteur avec terre de protection.

 Der Netzstecker dieses Gerätes dient als Trennvorrichtung und muss frei zugänglich bleiben.
Français: Lorsque la prise du réseau d'alimentation est utilisée comme dispositif de déconnexion, ce dispositif doit demeurer aisément accessible.

3.3. Vorsicht

 Um die Gefahr von Bränden oder elektrischen Schlägen zu verringern, dürfen die Schrauben nicht entfernt werden. Es befinden sich keine vom Anwender zu wartenden Teile in diesem Gerät, Wartungsarbeiten müssen von hierfür qualifizierten Servicemitarbeitern durchgeführt werden.
Français: Pour réduire le risque d'incendie ou de choc électrique, ne pas retirer les vis. Aucune pièce réparable par l'utilisateur. Confier l'entretien à personnel qualifié.

3.4. Verantwortung des Anwenders

3.4.1. Erdung Netzanschluss

Ihr Verstärker muss an eine geerdete Steckdose angeschlossen werden.

3.4.2. Lautsprecherausgang an Verstärkern – Gefahr

Verstärker können gefährliche Ausgangsspannungen erzeugen. Um einen elektrischen Schlag zu vermeiden, dürfen Sie freiliegende Lautsprecherkabel nicht berühren, während der Verstärker in Betrieb ist. Der Anschluss externer Kabel an die Lautsprecherklemmen muss von einer hierfür qualifizierten Person vorgenommen werden, oder es müssen vorgefertigte, hierfür geeignete Kabel verwendet werden.

Da an den Leistungsausgängen von Verstärkern Hochspannung anliegt, dürfen Lautsprecherkabel nicht angeschlossen oder abgezogen werden, so lange der Verstärker mit Netzspannung versorgt wird.

3.4.3. Rundfunkstörungen

Ein Muster dieses Produkts wurde auf Einhaltung der Grenzwerte der Europäischen Richtlinie für Elektromagnetische Verträglichkeit (EMV) geprüft und entspricht diesen Vorgaben. Dieses Gerät ist geprüft worden und entspricht den Grenzwerten der Federal Communications Commission (FCC) für digitale Geräte der Klasse

B nach Abschnitt 15. Diese Einschränkungen sollen angemessenen Schutz vor schädlichen Störungen durch elektrische Geräte gewährleisten. Dieses Gerät verwendet Hochfrequenzenergie. Wenn es nicht entsprechend der Anleitung installiert und verwendet wird, erzeugt es möglicherweise beeinträchtigende Störungen bei anderen Geräten, beispielsweise Rundfunkempfängern.

Dieses digitale Gerät der Klasse A entspricht den kanadischen Bestimmungen für Interferenz verursachende Geräte ICES-003.
Cet appareil numérique de la classe A est conforme à la norme NMB-003 du Canada.

Es kann jedoch nicht garantiert werden, dass es bei einer bestimmten Aufstellung nicht zu Interferenzen kommt. Wenn dieses Gerät Störungen bei Radio- und Fernsehempfangsgeräten auslöst – was durch Aus- und Anschalten des Gerätes überprüft werden kann – sollten Sie die folgenden Maßnahmen ergreifen:

- Richten Sie die Antenne neu aus oder stellen Sie die Antenne an einer anderen Stelle auf.
- Vergrößern Sie den Abstand zwischen dem Gerät und dem Empfänger.
- Schließen Sie das Gerät an eine Steckdose an, die zu einem anderen Stromkreis als der Empfänger gehört.
- Prüfen Sie, ob das betroffene Gerät den EMV-Grenzwerten für Störfestigkeit (CE-Kennzeichnung) entspricht. Wenn dies nicht der Fall ist, müssen Sie das Problem mit dem Hersteller oder Lieferanten dieses Produkts klären. Für alle elektrischen Produkte, die innerhalb der EU verkauft werden, muss eine Zulassung vorliegen, welche die Störfestigkeit gegen elektromagnetische Felder, Spannungsüberschläge oder Funkstörungen bestätigt.
- Bitten Sie Ihren Händler oder einen erfahrenen Radio-/Fernsehtechniker um Hilfe.

3.4.4. Beschädigung der Lautsprecher

Dieser Verstärker verfügt über eine sehr hohe Leistung und kann sowohl angeschlossene Lautsprecher als auch Menschen gefährden. Viele Lautsprecher können durch zu hohe Leistung leicht beschädigt oder zerstört werden. Achten Sie stets auf die Dauer- und Spitzenleistung der verwendeten Lautsprecher. Obwohl Dämpfungsglieder im Verstärker zum Absenken der Ausgangsleistung verwendet werden können, wird möglicherweise bei einer Anhebung des Eingangssignalpegels die volle Ausgangsleistung abgegeben, was zu Schäden an den angeschlossenen Lautsprechern führen kann.

3.4.5. Wartung

Um einen sicheren und zuverlässigen Betrieb zu gewährleisten, sollten die Staubfilter auf beiden Seiten der Frontplatte, hinter den Gittern, in regelmäßigen Abständen entfernt und gereinigt werden, um einen maximalen Luftstrom durch das Gerät zu gewährleisten.

Wenn die Staubfilter nicht instandgehalten werden, kommt es zu Sicherheitsrisiken. So kann es beispielsweise zu hohen Temperaturen im Geräteinneren kommen, die den Staub entzünden und ein Feuer auslösen können. Es besteht auch die Gefahr von Fehlfunktionen, da für den Betrieb des Gerätes ein konstanter Luftstrom von der Vorderseite zur Rückseite erforderlich ist. Wenn die Staubfilter nicht sauber gehalten werden und es zu einer Funktionsstörung des Gerätes kommt, so werden die resultierenden Probleme nicht durch die Garantie abgedeckt.

1. Instrucciones importantes de seguridad

Antes de usar este aparato, asegúrese de leer completamente estas Instrucciones de seguridad. Conserve este documento junto con el dispositivo.

1. Lea estas instrucciones.
2. Conserve estas instrucciones
3. Cumpla con lo indicado en los avisos.
4. Siga todas las instrucciones.
5. No utilice este aparato cerca del agua.
6. Límpielo solo con un trapo seco.
7. No bloquee ninguna de las ranuras de ventilación. Instale este aparato de acuerdo con las instrucciones del fabricante.
8. No instale este aparato cerca de fuentes de calor como radiadores, calentadores, hornos u otros aparatos (incluyendo amplificadores) que produzcan calor.
9. No elimine el sistema de seguridad que supone el enchufe polarizado o con toma de tierra. Un enchufe polarizado tiene dos bornes, uno más ancho que el otro. Uno con toma de tierra tiene dos bornes iguales y una tercera lámina para la conexión a tierra. El borne ancho o la lámina se incluyen para su seguridad. Si el enchufe que venga con la unidad no encaja en su salida de corriente, haga que un electricista cambie su salida anticuada.
10. Evite que el cable de corriente quede de forma que pueda ser pisado o quedar retorcido o aplastado, especialmente en los enchufes, receptáculos o en el punto en el que salen del aparato.
11. Use solo accesorios/complementos especificados por el fabricante.
12. Utilice este aparato solo con un soporte, trípode o bastidor especificado por el fabricante o que se venda con el propio aparato. Cuando utilice un bastidor con ruedas, tenga cuidado al mover la combinación de aparato/bastidor para evitar que vuelque y puedan producirse daños.
13. Desconecte este aparato de la corriente durante las tormentas eléctricas o cuando no lo vaya a usar durante un periodo de tiempo largo.
14. Dirija cualquier posible reparación solo al servicio técnico oficial. Este aparato deberá ser reparado si se ha dañado de alguna forma, como por ejemplo si el cable de corriente o el enchufe están rotos, si ha sido derramado algún líquido sobre la unidad o algún objeto ha sido introducido en ella, si ha quedado expuesto a la lluvia o la humedad, si no funciona normalmente o si ha caído al suelo en algún momento.
15. Use el enchufe del cable de alimentación para desconectar este aparato de la corriente eléctrica.
16. PRECAUCIÓN: Para reducir el riesgo de incendios o descargas eléctricas, no permita que este aparato quede expuesto a la lluvia o la humedad.
17. No permita que este aparato quede expuesto a salpicaduras de ningún tipo y no coloque objetos que contengan líquidos, como jarrones, encima de este aparato.
18. Dado que el cable de alimentación es el sistema de desconexión de esta unidad debe ubicarla de forma que siempre pueda acceder a él.
19. No conecte la salida de esta unidad a una fuente de voltaje como una batería, salida de corriente o adaptador, independientemente de si la unidad está encendida o apagada.
20. No retire la carcasa ni la tapa inferior. El hacerlo supondrá un riesgo de exposición a voltajes peligrosos. Dentro de este aparato no hay piezas susceptibles de ser reparadas por el propio usuario y el retirar la tapa anularía la garantía.
21. El uso de este aparato debe ser supervisado por un profesional, especialmente en el caso de que lo vayan a usar adultos inexpertos o menores.
22. La cláusula 16.3 de la US National Differences obliga al uso de cables de red de una categoría mínima de VW-1.



2. Certificaciones



Este aparato cumple con los requisitos de la Directiva EMC 2014/30/EU y con los de la Directiva de Bajo Voltaje 2014/35/EU.

Standards aplicados: Emisión EMC EN55032, Class A, EN55103, E4.
Inmunidad EMC EN55103-2, E4, con relación S/R inferior al 1% a nivel operativo normal.
Seguridad eléctrica EN60065, Clase I



Se ha verificado que este aparato cumple con el standard de seguridad estadounidense ANSI/UL 60065 y con el standard canadiense de seguridad CSA C22.2 NO. 60065. Las pruebas fueron realizadas por Intertek, uno de los laboratorios de pruebas autorizados a nivel nacional (NRTL).

3. Precaución

3.1. Explicación de los símbolos gráficos



El símbolo de un rayo dentro de un triángulo equilátero se usa para alertar al usuario de la presencia de "voltajes peligrosos" no aislados dentro de la carcasa del aparato que pueden ser de magnitud suficiente para constituir un riesgo de descarga eléctrica para las personas.



El símbolo de exclamación dentro de un triángulo equilátero se utiliza para advertir al usuario de la existencia de importantes instrucciones de uso y mantenimiento (reparaciones) en los documentos que acompañan a la unidad.

3.2. Precauciones

Para evitar el riesgo de descargas eléctricas, no retire la carcasa ni el panel inferior. Dentro de este aparato no hay ninguna pieza susceptible de ser reparada por el usuario. Dirija cualquier posible reparación al servicio técnico.
Français: À prévenir le choc électrique n'enlevez pas les couvercles. Il n'y a pas des parties serviceable à l'intérieur, tous reparations doit être faire par personnel qualifié seulement.



3. Precaución



Para desconectar este aparato completamente de la corriente eléctrica, extraiga el enchufe del cable de alimentación de la salida de corriente. Por este motivo, coloque el cable de forma que siempre pueda acceder a él.

Français: Pour démonter complètement l'équipement de l'alimentation générale, démonter le câble d'alimentation de son réceptacle. La prise d'alimentation restera aisément fonctionnelle.



Para reducir el riesgo de un incendio o una descarga eléctrica, no permita que este aparato quede expuesto a la lluvia o la humedad.

Français: Pour réduire les risques d'incendie ou de choc électrique, n'exposez pas l'appareil à la pluie ou à l'humidité.



No permita que este aparato quede expuesto a salpicaduras de ningún tipo y no coloque objetos que contengan líquidos, como jarrones, encima de este aparato.

Français: N'exposez pas ce système/appareil au ruissellement ni aux éclaboussures et assurez-vous qu'aucun objet contenant du liquide tel qu'un vase n'est placé sur l'appareil.



Conecte este aparato a una salida de corriente que disponga de una conexión de toma de tierra de seguridad.

Français: Cet appareil doit être raccordé à une prise secteur avec terre de protection.



Dado que el cable de alimentación es el sistema de desconexión de esta unidad debe ubicarla de forma que siempre pueda acceder a él.

Français: Lorsque la prise du réseau d'alimentation est utilisé comme dispositif de déconnexion, ce dispositif doit demeurer aisément accessible.

3.3. Precaución



Para reducir el riesgo de un incendio o una descarga eléctrica, no quite ninguno de sus tornillos. Dentro de este aparato no hay ninguna pieza susceptible de ser reparada por el usuario. Dirija cualquier posible reparación al servicio técnico.

Français: Pour réduire le risque d'incendie ou de choc électrique, ne pas retirer les vis. Aucune pièce réparable par l'utilisateur. Confier l'entretien à personnel qualifié.

3.4. Responsabilidad del usuario

3.4.1. Toma de tierra de la conexión eléctrica

Debe conectar este amplificador a una salida de corriente dotada de toma de tierra de seguridad.

3.4.2. Riesgos de las salidas de altavoces de los amplificadores

Los amplificadores son capaces de producir voltajes de salida potencialmente peligrosos. Para evitar una descarga eléctrica, no toque ningún cable de altavoz desnudo mientras el amplificador esté en marcha. La conexión de cables a las terminales de altavoces debe ser realizada por un profesional, o debe asegurarse en todo caso de usar cables específicos para ello y de unas especificaciones adecuadas.

Dado que los canales de salida de potencia de los amplificadores producen un alto voltaje, no conecte ni desconecte cables de altavoz con la unidad encendida.

3.4.3. Interferencias de radio

Se ha verificado que este aparato cumple con los límites establecidos por la directiva europea de compatibilidad electromagnética (EMC). También se ha verificado que este aparato cumple con los límites establecidos para dispositivos digitales de clase A, de acuerdo a lo expuesto en el apartado 15 de las normas FCC. Estos límites han sido diseñados para ofrecer una protección razonable contra las interferencias molestas procedentes de aparatos eléctricos. Este aparato usa energía de radiofrecuencia y, si no es instalado y usado de acuerdo a lo indicado en estas instrucciones, puede dar lugar a interferencias en otros aparatos tales como receptores de radio.

Este aparato digital de clase A cumple con la norma canadiense ICES-003. Cet appareil numérique de la classe A est conforme à la norme NMB-003 du Canada.

No obstante, no está garantizado que este tipo de interferencias no se produzca en una instalación concreta. Si este aparato da lugar a interferencias molestas en la recepción de la señal de radio o TV (lo que podrá determinar rápidamente apagando y volviendo a encender este aparato), el usuario será el responsable de tratar de corregir dichas interferencias por medio de una o más de las medidas siguientes:

- Reorientar o reubicar la antena receptora.
- Aumentar la separación entre este aparato y el receptor.
- Conectar este aparato a una salida de corriente o regleta diferente a la que esté conectado el receptor.
- Verificar si la unidad afectada cumple con los límites EMC en cuanto a inmunidad (etiqueta CE). Si no los cumple, consulte el problema con el fabricante o distribuidor. Todos los aparatos eléctricos comercializados dentro de la CE deben cumplir con los límites de inmunidad frente a campos electromagnéticos, picos de alto voltaje e interferencias de radio.
- Consultar a su distribuidor o a un técnico especialista en radio/TV para que le ayuden.

3.4.4. Daños en los altavoces

Los amplificadores son muy potentes y pueden llegar a resultar potencialmente peligrosos tanto para los altavoces como para las personas. Muchos altavoces pueden resultar dañados fácilmente o incluso destruidos por una sobrecarga. Verifique siempre cuáles son las capacidades de potencia continua y en picos del altavoz. Aunque puede usar los atenuadores del amplificado para reducir la ganancia global, un aumento de la señal de entrada puede dar lugar a una señal a máxima potencia de salida, capaz de dañar los altavoces conectados.

3.4.5. Mantenimiento

Para garantizar un funcionamiento seguro y fiable, debe retirar y limpiar de forma regular los filtros de polvo que se encuentran a ambos lados del panel frontal, detrás de las rejillas, asegurando así un correcto flujo de aire.

El no realizar este mantenimiento preventivo de los filtros puede dar lugar a riesgos de seguridad; por ejemplo, la elevada temperatura interna puede hacer que el polvo llegue a arder y provoque un incendio. También existe el riesgo de averías de la unidad debido a un flujo de aire incorrecto en su interior. Cualquier avería resultante de una limpieza incorrecta de los filtros no quedará cubierta por la garantía.

4. Table of Contents

1. Important safety instructions	3
2. Approvals	3
3. Warnings	3
3.1. Explanation of warning symbols	3
3.2. Warnings	3
3.3. Caution	4
3.4. User responsibility	4
3.4.1. Mains connection grounding	4
3.4.2. Speaker output hazard on amplifiers	4
3.4.3. Radio interference	4
3.4.4. Speaker damage	4
3.4.5. Maintenance	4
5. Introduction	17
5.1. Welcome	17
6. Feature summary	17
6.1. Amplifier Platform Features.....	17
6.2. Lake Processing Features	18
7. Installation	18
7.1. Unpacking	18
7.1.1. Included in the box	18
7.2. Mounting	19
7.2.1. Rear Mounting	19
8. Cooling and fan operation	20

9. Operating voltage	20
9.1. Low voltage country considerations	21
10. Grounding	22
11. Product overview	22
11.1. Front panel	22
11.2. Rear panel	24
12. Signal flow and processing	26
13. Quick Start Tutorial	27
13.1. Network setup	27
13.1.1. Network connections / topology	27
13.1.2. Network configuration	27
13.2. Software installation and firmware update	28
13.2.1. Lake Controller software suite	28
13.2.2. CAFÉ software	28
13.2.3. Firmware update	28
13.3. System setup	29
13.4. Rational Power Management™	32
14. Faults and warnings	34
15. Technical Specifications	37
16. Warranty and support	39
16.1. General	39
16.2. Technical assistance and service	39
16.2.1. International service	39
16.2.2. Factory service	40

5. Introduction

5.1. Welcome

Thank you for choosing the Lab.gruppen PLM+ Series for your sound reinforcement needs. We are confident that you will be pleased with the performance, unique features, configuration flexibility, reliability, and long-term durability offered by this product.

For fast installation and use of this product, your welcome package includes this printed copy of the PLM+ Series Quick Start Guide. It provides a brief introduction to the features and functionality of the PLM+ Series, and it also contains the information required to safely install the product and place it in service. Please read through thoroughly to become acquainted with the basic configuration and control options available. It is recommended that you also review all other product documentation to ensure familiarity with the various configuration and control options.

Thank you again for placing your confidence in Lab.gruppen products.

6. Feature summary

6.1. Amplifier Platform Features

- Four channels with three levels of total available frame power output: 20000 W, 12000 W, and 5000 W (@ 2.67 ohms)
- Rational Power Management (RPM)
- True flexibility in allocating power output across each channel to match requirement for more efficient use of amplifier inventory
- Any channel is capable of delivering up to 5900 W (PLM5K44 = 2000 W) power output drawing from total available power in each frame
- Dedicated on-board surveillance and load monitoring for voice alarm applications
- Advanced universal power supply
- Regulated Switch-Mode Power Supply (R.SMPSTM) maintains stability through fluctuations in mains voltage
- Best-in-class Power Factor Correction (PFC)
- Current Draw Modeling (CDMTM) reduces peak mains draw
- Breaker Emulation Limiter (BELTM) responds to available mains distribution
- Under-Voltage Limiting (UVLTM) allows continued operation through mains voltage drop
- CAFÉ (Configuring Amplifiers For the Environment) software incorporates ESPTM (Equipment Specification Predictor) to assist in design, equipment specification and commissioning
- Features controlled by on-board DSP
 - Amp Gain (Sensitivity) - Input gain (sensitivity) is set in the digital domain and controlled via Lake Controller software
 - ISVPLTM - The Inter-Sample Voltage Peak Limiter (ISVPL) tailors each channel's power output to the characteristics of the connected load.
 - Load Verification & Performance Monitoring - A comprehensive set of proprietary DSP-based tools enables load verification and real-time performance monitoring.

6.2. Lake Processing Features

- Lake's exclusive classic/linear-phase/FIR speaker processing platform with four throughputs
- Group control with Raised Cosine™ MESA EQ™ asymmetric filters
- LimiterMax™ peak and RMS limiters
- Extensive loudspeaker preset database (Lake LoadLibrary™)
- Comprehensive clocking management system with low latency sample rate conversion
- Full support for Dante Controller
- Multiple and redundant inputs with programmable failover
 - Four "Lake Class" analog inputs with Iso-Float™ ground isolation
 - Two AES3 digital inputs (4 audio channels)
 - Eight dual-redundant Dante network audio inputs
- Comprehensive 3rd party protocol for integration potential with third- party matrix systems via purpose-developed middleware

7. Installation

7.1. Unpacking

Carefully open the shipping carton and check for any damage to the device or the supplied accessories. Every Lab.gruppen product is tested and inspected before leaving the factory and should arrive in perfect condition. If any damage is discovered, please notify the shipping company immediately. Only the consignee may initiate a claim with the carrier or their insurers for damage incurred during shipping. Save the carton and packing materials for the carrier's inspection.

7.1.1. Included in the box

In addition to the PLM+ device, the shipping carton includes the following items:

- PLM+ Quick Start Guide (this document)
- AC mains lead (power cable) with Neutrik® powerCON® connector (PLM20K44 and PLM12K44 only) and AC socket plug according to ordering selection. PLM5K44 uses a locking IEC connector.
- Rear brackets for additional rack support (pair) along with associated mounting hardware.

Please keep the original carton and associated packaging to facilitate shipping of the device should the need arise.

7.2. Mounting

PLM+ is made for mounting in 19 inch racks. Four screw holes are available for attachment of the amplifier to the racks front rack rail. This device has no top or bottom vents; therefore, units may be stacked directly on top of one another. Sufficient space should be available at the rear to accommodate connectors and cables. In addition, allowance must be made for cable or loom bends within a rack.

7.2.1. Rear Mounting

Two rear support brackets, along with associated mounting hardware, are included with the PLM+ device. It is strongly recommended that these are used wherever possible. Fit the brackets to the vertical rails at the rear of the rack. The support brackets are reversible and may be fitted to point either to the front or rear of the rack; the proper orientation depends on the rack depth and position of the rear rack rails.

Rear support bracket with mounting hardware

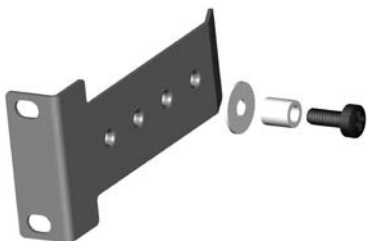

Rear support bracket mounted for fixed installation and bracket pointing forward

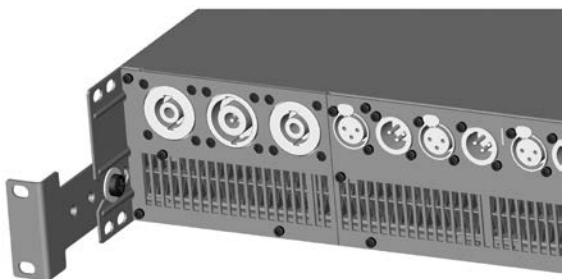

Rear support bracket mounted for removable installation and bracket pointing towards back



8. Cooling and fan operation

PLM+ devices use a forced-air cooling system with airflow from front to rear, allowing high continuous power levels without thermal problems. To facilitate maximum air flow, ensure that no objects such as rack doors or lids are placed at the front or rear of the rack. Never attempt to reverse the airflow. Make sure an adequate air supply is provided in front of the PLM+ device, and that the rear of the device has sufficient space to allow air to escape. It is recommended to keep the ambient temperature around the device as cool as possible. An increased temperature can have a significant negative impact on the expected lifetime on the components inside the PLM+ Series device.



Note: Fit solid blanks (not ventilation blanks) to unused rack spaces to ensure effective air circulation. Leaving gaps in between items of equipment degrades the effectiveness of forced-air cooling.

If installing one or more PLM+ devices in a rack with other fan-cooled equipment, confirm that all other equipment also uses front-to-rear airflow for cooling. If this precaution is not observed, there is a risk of overheating, as units with the reverse airflow will be drawing in air which has already been heated by the PLM+ Series devices.

The PLM+ device is equipped with a sophisticated temperature sensing system which protects it from any overheating which may occur as a result of inadequate ventilation.

9. Operating voltage

PLM+ Series has a universal power supply and its mains nominal and operating voltages are specified in the Technical Specifications (see section 15). PLM+ Series can be ordered with a variety of mains plugs. If the mains plug (AC plug) fitted to the mains cable (AC cord) is not appropriate for your country it can be removed and a locally-sourced one fitted instead. If you are not 100% confident of your competence to replace the mains plug (AC plug), the task should be carried out by qualified personnel.



Note: In-rush current is controlled and limited during the soft-start sequence. This enables multiple PLM+ Series Devices on the same AC mains circuit to be turned on simultaneously.

9.1. Low voltage country considerations

Although the PLM+ Series has a wide range of operating mains voltage, some considerations can be applicable for low voltage regions. PLM+ performs well throughout the specified nominal voltage range but has slightly better efficiency at higher voltages. For regions with nominal voltage below 140 V, one could consider connecting the amplifier in a three-phase delta or two phase split-phase configuration.



Note: Following connections applicable only for resulting voltage inside the amplifiers nominal voltage range.

Connecting the amplifier in three phase delta configuration

In three-phase configuration where the phases are 120 degrees apart, one can connect three balanced loads in a delta configuration. The connection is made between the phases instead of between the neutral and a phase.

Three phase delta configuration

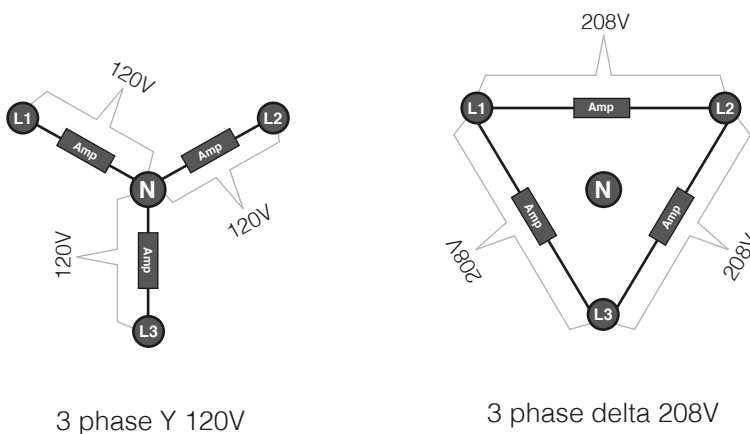

Connecting the amplifier in a split phase configuration

In two phase split-phase configuration there are two phases separated by 180 degrees. Connecting between the phases gives double the line voltage.

Two phase split-phase configuration



10. Grounding

Use correctly-shielded balanced audio input connections to minimize hum and interference.

PLM+ Series must be grounded (earthed) with the safety ground pin to the mains distribution system. NEVER disconnect the earth (ground) pin on the mains cable (AC power cord).

11. Product overview

11.1. Front panel

Additional information on operations using front panel controls is available in the full PLM+ Series Operation Manual.

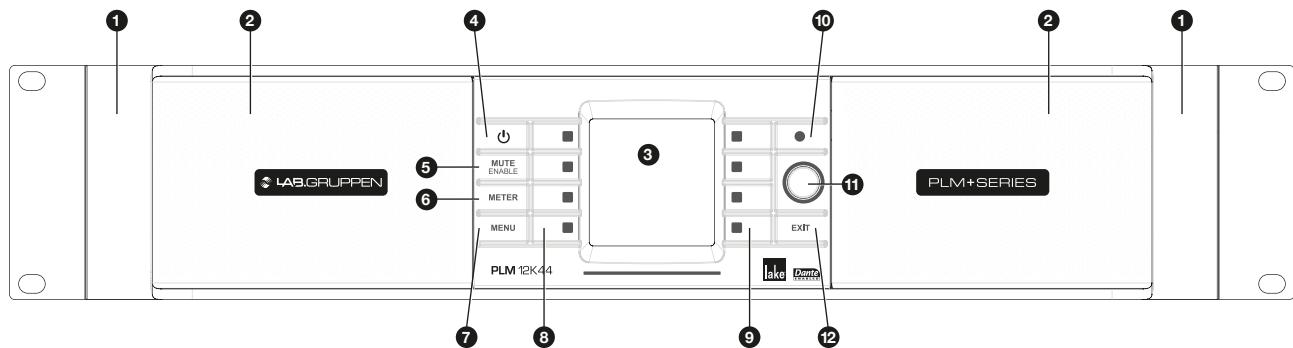

1 Handles – Handles should be used when carrying, and when fitting into or removing from a rack. Ensure that rack doors or covers have sufficient depth to clear the handles.

2 Dust Filters – Two dust filters are located behind metal covers. Loosen thumbscrews behind the handles to remove covers and remove filter elements for cleaning.



Note: NEVER operate this device without the dust filters in place.

3 Display – The display illuminates when device is on. Brightness and contrast can be adjusted via the front panel menu. A Screen Saver function turns off the display after 30 minutes of no activity. Press any button to turn on the display.

4 Standby – Switches device between On and Standby power modes.

- ⑤ **Mute Enable** – Selection of MUTE ENABLE allows dynamic function buttons to operate as Mute controls for the module inputs and power output channels. The MUTE ENABLE button flashes when the mode is selected; a subsequent press deselects the mode. If left activated, MUTE ENABLE mode will automatically disable two minutes after last mute action.
- ⑥ **Meter** – Successive presses of the METER button scroll through meter views: Amp, Temperature, Input and Module meters, returning to Home. Pressing METER from Menu Mode returns display to Meter Mode Home view.
- ⑦ **Menu** – Pressing the MENU button changes the display to the top level menu, with dynamic function buttons enabling access to various information displays and function settings.
- ⑧ **Dynamic Function Buttons with LEDs (Left of LCD)** – The function of these buttons change according to the currently selected view or menu.
- In Menu Mode they are used for menu navigation and for parameter selection
 - In Meter mode they provide Mute/Unmute function for the four inputs in conjunction with MUTE ENABLE. Internal mute point(s) depend on selected meter view. The four LEDs display mute status (red= mute, green = unmute) as well as fault and warning indications. Global faults and warnings are indicated by simultaneous illumination of all four LEDs. Please refer to full Operation Manual for more information.
- ⑨ **Dynamic Function Buttons with LEDs (Right of LCD)** – The function of these buttons change according to the currently selected view or menu.
- In Menu Mode they are used for menu navigation and for parameter selection
 - In Meter mode they provide Mute/Unmute function in conjunction with MUTE ENABLE. Internal mute point(s) depend on selected meter view. Please refer to full Operation Manual for more information.
- All LEDs provide mute, clip, fault and warning indication for the power output channels.
- ⑩ **Communication LED** – Steady white illumination indicates Module/Frame is selected in Lake Controller; flashing indicates communication with Lake Controller. Brightness is adjustable in the Frame page of Main menu.
- ⑪ **Rotary Encoder** – Turning the encoder modifies various parameters in the menu. The ring around the encoder illuminates whenever a menu item is selected that permits adjustment of values. In Home view, the encoder is used to scroll through Meter views.
- ⑫ **Exit** – Pressing EXIT returns the menu up one level when navigating in Menu mode. In Meter mode, EXIT returns display to Home view.

11.2. Rear panel

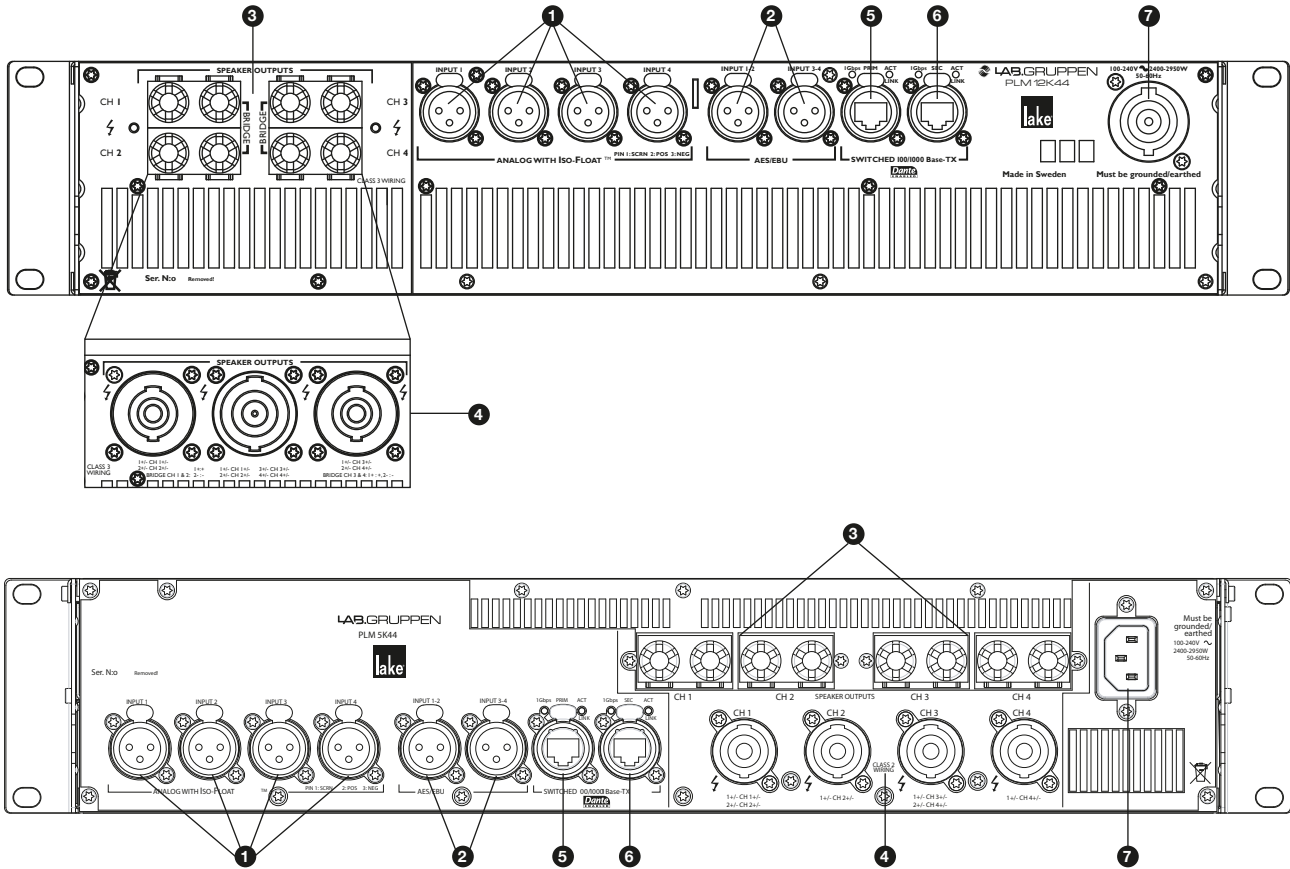

Input Connectors

❶ **Analog Inputs** – Four analog inputs are available on standard XLR-3F connectors, electronically balanced and featuring Lake Iso-Float circuitry. Impedance is 20 kohms; maximum input level is +26 dBu.

❷ **AES3 Inputs** – Two latching XLR-3F connectors accept four channels of AES3 digital audio. Input impedance is 110 ohms; ensure that 110 ohm digital audio cables are used.

Output Connectors

Your device will be equipped with one of the two output connector options. Both options allow for Bridge Mode operation (PLM20K44 and PLM12K44 only), which is activated in the Lake Controller software. Please refer to the Lake Controller Operation Manual for more information. The PLM5K44 is equipped with both binding posts and speakON connectors, and does not support Bridge Mode operation.

❸ **Binding Posts** – Power outputs are available on four separate pairs of fully enclosed binding posts.

❹ **speakON connectors** – Power outputs are available simultaneously on a single 8-pole connector (PLM20K44 and PLM12K44 only) and on two 4-pole connectors. The four-pole connectors carry outputs for channels 1&2 and 3&4 respectively. For PLM5K44, connector 1 carries output channels 1 and 2, connector 2 carries channel 2, connector 3 carries channel 3 and 4, and connector 4 carries channel 4.

Ethernet and Power Connectors

5 Primary Network Connector – The primary Neutrik RJ45 etherCON® connection provides integration into an Ethernet control network which may include other Lake Processors and the Lake Controller software. Network connection permits full control of all functions along with real-time metering from a remote position. This device supports the Dante audio networking protocol for multichannel, high-definition digital audio over the same Ethernet connection.

Use the primary connector when using a star network topology, consisting of individual Cat-5e connections between the devices and an Ethernet switch. Alternatively, this connection can be used to daisy chain directly to another Lake Processor. The daisy chain topology should not be used with Dante.

For a technical reference of the Ethernet Port, please refer to the full PLM+ Series Operation Manual. Additional information is also available in the Lake Network Configuration Guide.



Note: Additional processor configuration is required for a dual redundant network setup. See the Lake Controller Operation Manual for further details.



Note: Do not create a closed loop when configuring multiple devices in an Ethernet network; this will cause a network malfunction.

6 Secondary Network Connector – The secondary network connector can be used to daisy-chain multiple PLM+ Series devices. Alternatively, a Dante dual-network topology can be created by connecting all secondary network connectors to a separate Ethernet switch, ensuring full redundancy in the event of a network component failure.

7 Mains Power Connector – AC mains input for the PLM20K44 and PLM12K44 is via a Neutrik powerCON connector, rated at 32A. Connector mates with supplied AC mains cable. PLM5K44 uses a standard IEC locking connector. See previous section on Operating Voltage for more information.

12. Signal flow and processing

The table below depicts the audio signal flow for a PLM+ device.

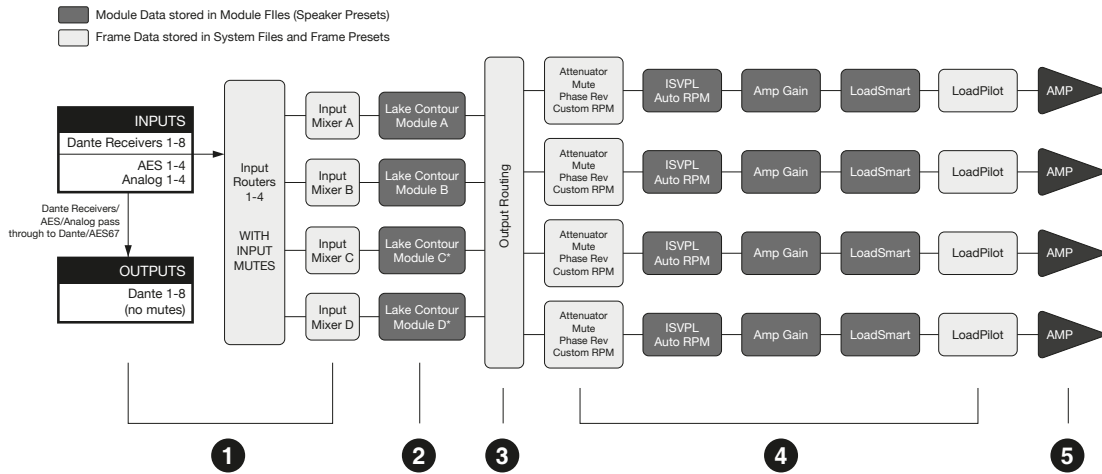

- ❶ The input section (inputs, input router and input mixer) allows for mixing capabilities as well as redundant and prioritized inputs with automatic switch-over in case of signal failure.
- ❷ Up to four Lake Processing modules provide user EQ and loudspeaker processing, including LimiterMax limiting.
- ❸ The Output router allows free routing between module outputs and power output channels.
- ❹ Each power output channel provides individual channel processing, including ISVPL limiter, RPM and load monitoring.
- ❺ Power Amplifier

13. Quick Start Tutorial

This section will describe how to get started with associated software and set up a basic system for operation.

13.1. Network setup

13.1.1. Network connections / topology

Each frame has two network ports; a primary and a secondary. See the below diagram for a typical network topology using the primary ports.

By default, the secondary ports are configured in dual redundancy mode to support a second redundant network. The alternate configuration for the two ports is a switch mode which allows daisy-chaining devices in a single network. Daisy chain mode is not recommended for more than a few devices, and for not more than two if running Dante audio along with control data.

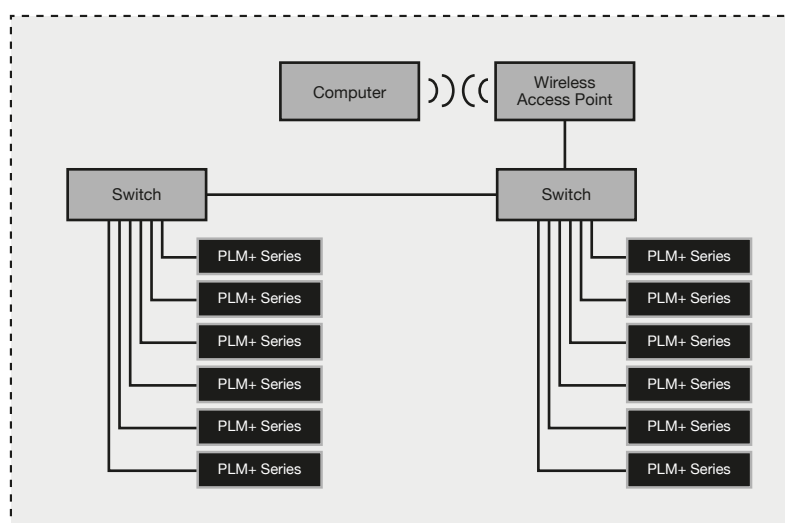

Note: If using Dante audio in the network, the audio traffic needs to be filtered from reaching the wireless links.

13.1.2. Network configuration

Frames are configured by default to obtain IP addresses automatically. The frame will assign itself an IP address in the link local range (169.254.1.0 through 169.254.254.255). If a computer is configured the same way (which should be default on modern operating systems), it will reside in the same subnet as the devices and communication can be established. Alternate configurations would be DHCP for a managed network or fixed IP. To connect to the secondary network in dual redundancy mode the computer shall be configured with an IP address in the 172.31.0.0 - 172.31.255.255 range.

13.2. Software installation and firmware update

13.2.1. Lake Controller software suite

1. The Lake controller software suite includes the Lake controller and accompanying utilities: Lake LoadLibrary and Dante discovery services. Download the Lake Controller installation from www.labgruppen.com.
2. Execute the installer and follow the on-screen instructions. This is a typical software installation where the default settings are acceptable for the vast majority of users.

13.2.2. CAFÉ software

1. The CAFÉ software is available as a separate installer on www.labgruppen.com.
2. Execute the installer and follow the on-screen instructions. This is a typical software installation where the default settings are acceptable for the vast majority of users.

13.2.3. Firmware update

The latest firmware for the product is included in the Lake controller installation. It is likely that firmware installed on the new product is older and requires updating.

1. Make sure all frames are powered on and connected through a wired network.
2. Launch the Lake firmware update utility LakeUpdate.exe.
3. Select the appropriate product range.
4. If more than one network adapter is enabled, a prompt will appear requiring selection of the adapter connected to the frames.
5. If prompted, allow the application access through the Firewall.
6. Latest firmware is preselected.
7. Discovered frames are listed. Tap Select Old and Update to initiate firmware update of all outdated frames. Frames already up to date will not be selected.
8. Read warning message and tap OK.
9. Wait for all updates to be completed. A wait indication will display on the unit(s) during updating. (Four corner LEDs will blink yellow in circular pattern.)
10. Follow the on screen instructions. Amplifiers with firmware associated with Lake Controller 6.5.0 or later will automatically power cycle the mains power, whereas amplifiers with older firmware will display a message that a manual power cycle is required (Note: A manual power cycle requires the mains plug to be completely removed, the standby button does not complete the firmware update.)
11. If internal updates are needed, these will be performed by the frame after the power cycle. A wait indication is displayed.
12. Tap Exit to close the update utility.

13.3. System setup

This tutorial provides a step-by-step guide for configuration of a typical professional loudspeaker system and provides an overview of the basic features and operation of the frame. It describes how to configure 4-channel frame for use with a generic 3-way loudspeaker system (with separate HF, MF and LF drivers), plus a separate subwoofer. It assumes that the system is fed with analog outputs from a mixing console with one fullrange main output and a separate sub feed.

1. Connect the loudspeakers to the four power output channels:
 - a. Channel 1 – Low Frequency Driver
 - b. Channel 2 – Mid Range Driver
 - c. Channel 3 – High Frequency Driver
 - d. Channel 4 – Subwoofer
2. Connect the main output of the mixing console to analog input 1 of the frame and the sub feed to input 2. While configuring, it is a good practice to make sure the volume is turned down on the console.
3. Ensure the frame is powered on and is in its default state, and that the computer has established an active Ethernet connection.
4. On the Tablet PC, launch the Lake Controller software application. Select the appropriate network adapter if more than one is enabled, and tap NO to the dialog asking whether to load the previous configuration.
5. Tap MODULES button on the menu bar at the bottom of the screen to access the Module Menu and scroll bar.
6. On the Module scroll bar, the frame is represented with a frame containing four discs. These are labeled A, B, C and D, each representing one of the four Lake processing modules.
7. Tap the frame to select it, then tap again in the MAIN area of the screen to place all modules of the frame in the current system configuration. The Lake Controller uploads settings from the frame.



8. Tap the icon for Module A; its border will turn yellow to confirm selection and an LED on the front panel of the associated device will illuminate.
9. Tap the Module Store/Recall button on the Modules Menu; the menu will change to show additional options.
10. Double-tap the Default Modules folder, then double-tap the Contour Classic Crossovers folder. A set of loudspeaker symbols will be displayed.
11. Tap CL3way, and then tap the RECALL button. This configures the DSP for the Module A as a 3-way crossover for the 3 way speaker.
12. Tap Yes when asked to confirm that all data will be overwritten.
13. An Output configuration dialog will pop up to allow for routing of module outputs to power channels. Tap the orange number buttons in the matrix to un-route, freeing up a power channel. Tap a blue number button at the intersection of the appropriate module output and power channel, routing the module output to the power channel. Proceed until you have routing according to the picture across. Tap the bottom right return button to exit the dialog.

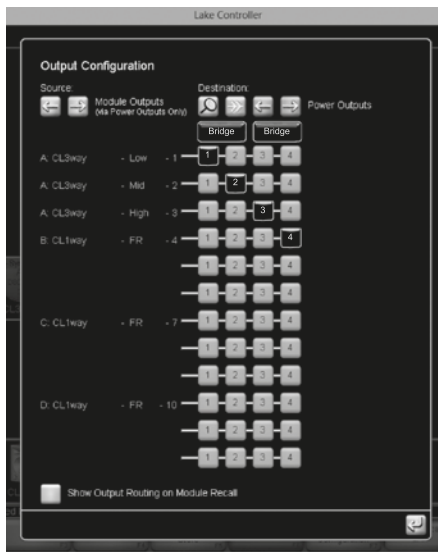

14. The B module is already a CL1way as default and can be used to drive the sub.
15. Tap Store/Recall EXIT to return to the Modules Menu.
16. Ensuring Module A (or any other module that you want to control) is selected (yellow border), tap I/O Config.



17. The right side of the I/O CONFIG screen displays a block diagram for the Modules. Tapping the different blue blocks will access the configuration screens for Input mixer, Levels, Input EQ, Delay and Output EQ/Crossover respectively. The magnifying glass at the far right end accesses the output configuration. (Note: Tapping the blue return button (left arrow), or the EQ/Levels EXIT button in the menu bar returns to the I/O Config screen from the various configuration screens.)

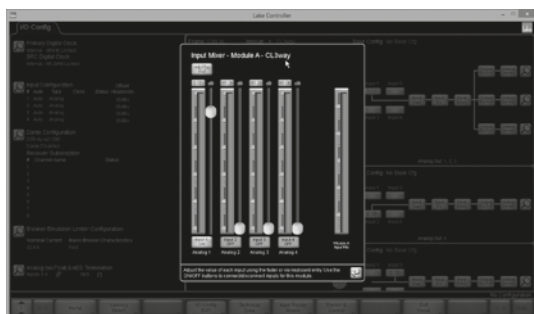

Input Mixer Configuration - Drag sliders and tap ON/OFF buttons to control input mixer settings.

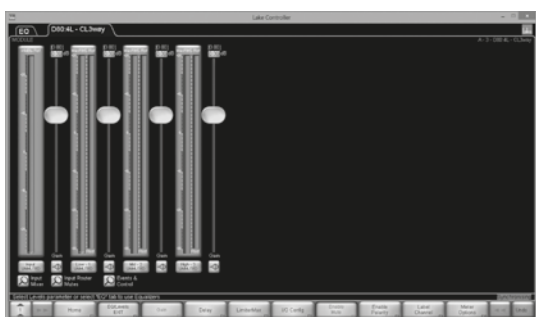

Levels Control - Drag sliders and tap mute buttons for module input and output channels.

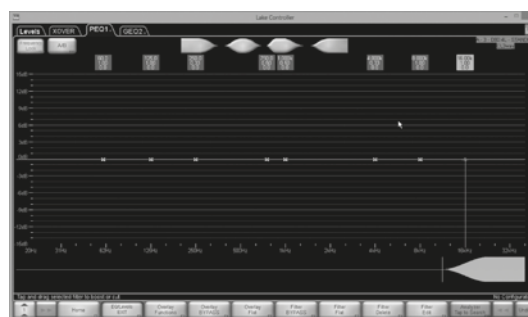

Parametric EQ control – Select filter on the top squares and adjust filter properties by dragging the controls. Sliders at the bottom control center frequency and Q (bandwidth). Gain is controlled in the main window area. Additional filters can be added by tapping the top filter objects and placing new filters on the main area.

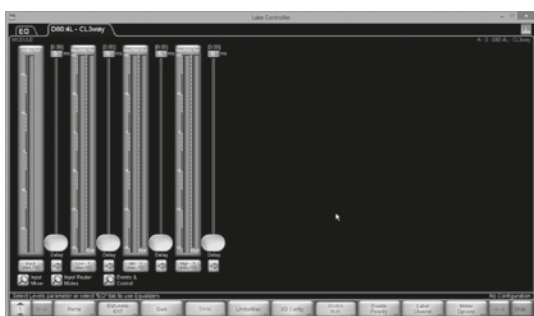

Delay Control - Drag sliders to control input and output delay

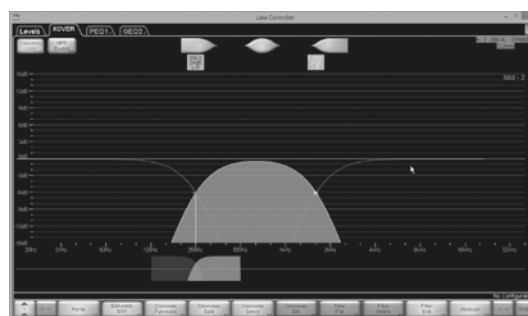

Crossover control – Select filters and drag on the bottom frequency bar to adjust crossover frequency. Crossover types may be changed by selecting the Crossover Functions button.

18. Tap the Input Gain button in the block diagram and unmute the Module Input Mute. Tap EQ/Levels Exit to return to IO Config.
19. The left side of the IO config screen holds frame configuration and summary for Clock configuration, Input configuration, Dante configuration, Breaker Emulation Limiter configuration and Analog Iso-Float & AES Termination configuration. All these configurations should be correct by default for this example.
20. From I/O CONFIG, tap EVENTS & CONTROL and navigate to the STATUS tab. If muted, unmute the power channels and slowly increase the volume on the appropriate feed from the mixing console. Audio should now be active at the outputs and heard through the loudspeakers. Close the Events and Control dialog with the return button and return to the main area by tapping the I/O Config EXIT button.



Events & Control, Status tab – Drag sliders to adjust power channel attenuation and tap mute buttons to control power channel mute. Metering and Status monitoring is available for each power channel.

21. Repeat step 16 and 20 for the B module. On the Output EQ/Crossover, tap the Aux Output Functions button on the menu bar and then tap LPF Enable button. Drag the Low pass filter control object on the frequency slider just above the menu bar to an appropriate crossover frequency for the sub, e.g. 100 Hz.

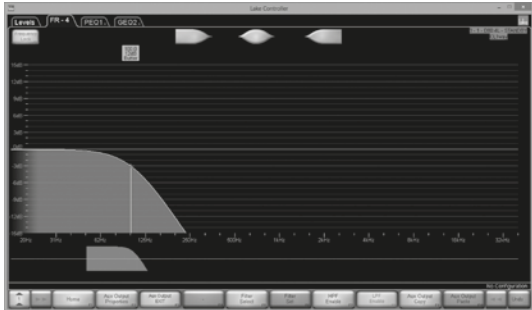

Output EQ control - Add LPF/HPF and EQ filters and drag to adjust.

22. Use the control options mentioned in 17 to tune your loudspeakers. For larger systems, modules can be placed in groups (Groups menu from the MAIN page) for control of multiple units.

13.4. Rational Power Management™

Rational Power Management™ (RPM) is a unique Lab.gruppen feature that allows for flexible allocation of power across channels of a PLM+. Power that is not used by one output channel is free for use by another output channel with greater demands. RPM allocates power up to the total limits of the specific amplifier model. RPM exists in two modes. See the image below.

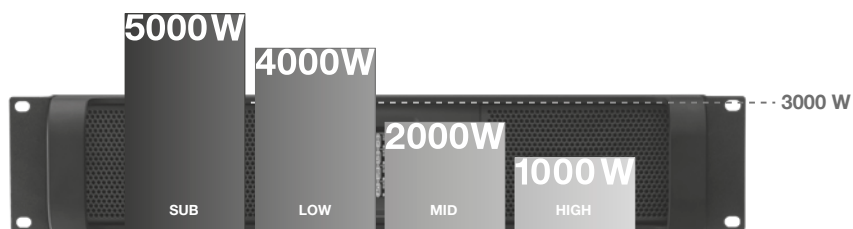

PLM 12K44 - Amp channels power adjusted to match the loudspeaker requirements

Auto RPM:

The frame will automatically allocate power per output channel according to the ISVPL settings in the Lake module. If the ISVPL settings taken together allow total output higher than the capabilities of the amplifier, RPM will reduce the ISVPL limiter thresholds evenly based on a proportional reduction in dB. When RPM is active, an RPM icon will be displayed next to the “Actual ISVPL” values in the Events & Control section.

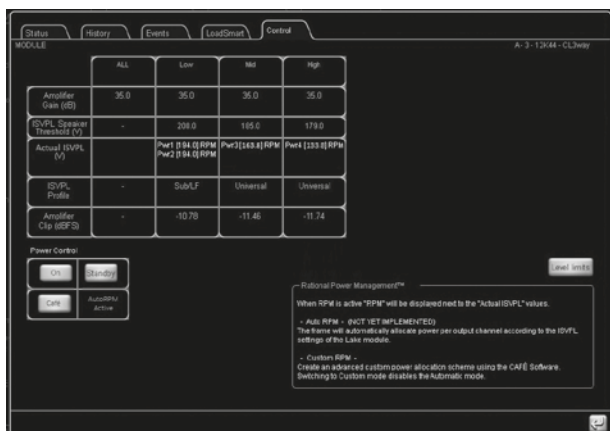
**Custom RPM:**

The Café software allows users to create an advanced custom power allocation scheme. Switching to Custom mode disables the Automatic mode. When RPM is active an RPM icon will be displayed next to the “Actual ISVPL” values in the Events & Control section. Please find more information about this in the CAFÉ Operation Manual

**CAFÉ with ESP:** Integrated software for efficient project planning and fast system configuration

CAFÉ (Configuring Amplifiers For the Environment) is a dedicated software application for Windows and OSX that provides tools for system planning, specification and commissioning. CAFÉ improves work flow efficiency at every stage of the project, from initial design through bid tender and final system optimization.

14. Faults and warnings

Category/Type	Name	On screen text	Description	Action
FRAME				
Warning	Lake Controller offline	CTRL OFFLINE	Frame unable to find Lake controller on the network	Check network cabling/ network if controller expected on the network
Warning	AES clock slipping	CLOCK SLIPPING	Frame not able to lock to incoming AES stream	Check AES sender and clock configuration
Warning	Dante device name conflict	NAME CONFLICT	Two or more devices on the network with the same Dante name	Review Dante configuration
Warning	Dante module not detected	DANTE NEEDS SERVICE	Lake cannot detect a functioning Dante module	Restart device; if not cleared it needs service to operate Dante
Warning	Dante module with incompatible firmware	DANTE FW INVALID	Dante module not loaded with correct FW	Retry updating the firmware with LakeUpdate
Warning	Audio Fault	AUDIO FAULT	Internal audio interface not functioning	Restart device; if not cleared it needs service
Warning	Sense fault DSP	SENS FLT:DSP	Voltage and current sensing on amplifier output faulty. Audio continues but protection might be compromised. No load monitoring	Restart device; if not cleared it needs service
Fault	A/D converter power supply fault	A/D PSU FAULT	Voltage supply to the analog input converters faulty	Restart device; if not cleared it needs service for analog input to work
TEMP				
Warning	Temperature warning power supply	TEMP WARN:PSU	Power supply temperature approaching critical levels	Improve cooling or reduce output power to avoid temperature becoming critical
Warning	Temperature warning DSP area	TEMP WARN:DSP	DSP area temperature approaching critical levels	Improve cooling or reduce output power to avoid temperature becoming critical
Warning	Power supply Temperature Limit	PTL ACTIVE	Amplifier is reducing output power to avoid power supply temp fault protection	Improve cooling or reduce output power to avoid limiting
Warning	Amp channel Temperature Limit	ATL ACTIVE	Amplifier channel is reducing output power to avoid amplifier channel temp fault protection	Improve cooling or reduce output power to avoid limiting
Fault	Temperature fault power supply	TEMP FLT:PSU	Power supply temperature reached internal protection limit	Automatically restarts when cooled down
Fault	Temperature fault DSP area	TEMP FLT:DSP	DSP area reached critical temperature	Improve cooling or reduce power

Category/Type	Name	On screen text	Description	Action
PSU				
Warning	Under Voltage Limit	UVL ACTIVE	The Under Voltage limiter is active as the mains supply is approaching the lower end of the device's operational voltage. Output power is decreased to ensure mains distribution does not collapse	Increase mains distribution stiffness or reduce output power to avoid limiting
Warning	Power Average Limit	PAL ACTIVE	Amplifier is reducing output power due to average power or mains current draw is above safe operating levels	Reduce output power to avoid limiting
Warning	Breaker Emulation Limit	BEL ACTIVE	Power supply is reducing mains current draw to stay within BEL configured nominal current and profile	Improve mains distribution and update BEL configuration or reduce output power to avoid limiting
Warning	Mains supply glitch	MAINS GLITCH	Mains glitch (missing cycles) was detected on the mains inlet	Check mains distribution/connection
Fault	Need service	NEED SERVICE:1-8	Power supply internal error	Restart device; if not cleared it needs service
Fault	Mains voltage above 400 volt peak	MAINS>400 VPK	Power supply detects mains voltage above 400 volt peak. Protective shut down, auto restart attempt	Check mains distribution/connection
Fault	Mains voltage above 270 V	MAINS>270 V	Power supply detects mains voltage above operation voltage. Protective shut down, auto restart attempt	Check mains distribution/connection
Fault	Mains voltage below 65 V	Mains<65 V	Power supply detects mains voltage below operation voltage. Protective shut down, auto restart attempt	Check mains distribution/connection
Fault	Power supply fault	PSU FAULT	Internal power supply fault	Check mains distribution/connection. Restart device; if not cleared it needs service
Fault	Check mains	CHECK MAINS	Power supply detects unstable mains supply. Protective shut down, auto restart attempt	Check mains distribution/connection
Fault	Power supply power protect	PSU POWER PROT	Too high output power for too low mains supply voltage. Protective shut down, auto restart attempt	Improve mains supply voltage or reduce output power
LOAD				
Warning	Speaker short	SPKR SHORT	Both LoadPilot tones below thresholds	Check load or calibration
Warning	Speaker damaged	SPKR DAMAGED	One LoadPilot tone is above or below threshold	Check load or calibration
Warning	Under speaker count	UNDER SPKR CNT	Both LoadPilot tones above thresholds or LoadSmart detected fewer speakers than expected	Check load and cabling alibration

14. Faults and warnings

Category/Type	Name	On screen text	Description	Action
Warning	More speakers	OVR SPKR COUNT	LoadSmart detected more speakers than expected	Check load and cabling or fingerprint
Warning	Uncertain about load	UNCERTAIN LOAD	LoadSmart uncertain about load	Check load and cabling or fingerprint
Warning	Load not verified	LOAD NOT VER	LoadSmart not verified	Perform LoadSmart verification
Fault	No load	NO LOAD	At least one LoadPilot tone above measurable area or significantly above thresholds	Check load or calibration
Fault	Wrong load	WRONG LOAD	LoadSmart detected impedance response output model	Check load and cabling or fingerprint
Fault	Short circuit	SHORT CIRCUIT	LoadPilot or full frequency analysis below short threshold or hardware short protection	Check load and cabling
AMP				
Warning	Temp warning amplifier channel	TEMP WARN	Amplifier channel is approaching critical temperature	Improve cooling or reduce output power to avoid temperature becoming critical
Fault	Temp Fault amplifier channel	TEMP FAULT	Amplifier channel has reached internal protection limit	Automatically unmutes when cooled down
Fault	Service channel	SERVICE CH.	Amplifier channel is damaged	Restart device; if not cleared it needs service
Fault	Very high frequency fault	VHF FAULT	Amplifier channel protection	Check input signal or reduce output. With a maximum of -12 dB of gain reduction in the VHF warning, VHF Fault will trigger after 15 seconds
Warning	Very high frequency warning	VHF WARNING (PLM20K/12K44 only)	Amplifier channel gain reduction due to VHF content	Check input signal
Clip	Current average limiter	CAL ACTIVE	Average current on amplifier above safe operating level	Reduce output power to avoid limiting
Clip	Current clip	CURRENT CLIP	Amplifier channel reached current limit	Reduce output power to avoid limiting
Clip	Voltage clip	VOLTAGE CLIP	Amplifier reached voltage limit	Reduce output power to avoid limiting
Clip	Module clip	MOD. CLIP	Module output signal clipped	Review gain structure. Module gain vs AmpGain
SIGNAL				
Fault	No input source	NO INPUT	Input router has no valid input source	Review input router settings/connections
Clip	Analog/AES input clip	INPUT CLIP	The signal on the analog/AES input is above inputs capability	Lower the signal on the feed to the amplifier

Table 9.1: Warning, Fault and Mute Indications (alphabetical by LCD Text / Event Log Text)

15. Technical Specifications

	PLM 5K44	PLM 12K44	PLM 20K44
General			
Processing / Network	Lake / Dante		
Numbers of amplifier channels	4		
Total burst power all channels (share among channels with RPM)	5000 W	12000 W	20000 W
Max. Output Power (all ch.'s driven) ¹⁾			
2 ohms	900 W	3000 W	4400 W
2.67 ohms	1250 W	3000 W	5000 W
4 ohms	1250 W	3000 W	4400 W
8 ohms	1250 W	1900 W	2300 W
16 ohms	700 W	950 W	1150 W
Hi-Z 70 V	1300 W	3000 W	3300 W
Hi-Z 100 V	1250 W	3000 W	4700 W
Max output power single channel ¹⁾			
2 ohms	900 W	4400 W	4400 W
2.67 ohms	1250 W	5900 W	5900 W
4 ohms	1750 W	4600 W	4600 W
8 ohms	1350 W	2300 W	2300 W
16 ohms	700 W	1150 W	1150 W
Hi-Z 70 V	1450 W	3300 W	3300 W
Hi-Z 100 V	2000 W	4700 W	4700 W
Amplifier output modules (all models, all channels)			
Peak output voltage	150 V	194 V	194 V
Max output current	30 A	67 A	67 A
Rational Power Management (RPM)	Any channel has potential to deliver the max single channel output power		
Default voltage limitation (can be lifted with RPM configuration)	147 V	175 V	194 V
Protection features	Current Average Limiter (CAL), Very High Frequency Protection (VHF), Direct Current Protection (DC), Short Circuit Protection, Current-Clip Limiter, Voltage Clip Limiter, Temperature protection		
Audio Performance (Amplifier platform with digital input)			
THD + N 20 Hz - 20 kHz for 1 W	< 0.05 %	< 0.05 %	< 0.05 %
THD + N at 1 kHz and 1 dB below clipping	< 0.04 %	< 0.04 %	< 0.04 %
Dynamic range	> 112 dB	> 114 dB	> 114 dB
Channel separation (Crosstalk) at 1 kHz	> 70 dB	> 70 dB	> 70 dB
Frequency response (1 W into 8 ohm, 20 Hz - 20 kHz)	+/- 0.05 dB	+/- 0.05 dB	+/- 0.05 dB
Internal sample rate / Data path	96 KHz / 32 bit floating point	96 KHz / 32 bit floating point	96 KHz / 32 bit floating point
Product propagation delay AES 96 kHz / analog input	1.61 / 1.68 ms	1.61 / 1.68 ms	1.61 / 1.68 ms
Lake processing			
Loudspeaker processing	Up to 4 modules of Classic/linear-phase/FIR cross-over, EQ, delay, LimiterMax™ - peak and RMS limiters		
System tuning	Group control with Raised Cosine™ MESA EGT™ asymmetric filters		
Input redundancy / Matrix	Automatic 4 level input redundancy / 4 input mixers		
System integration	Comprehensive 3rd party protocol over UDP Ethernet		
Measurement & Analysis			
Pilot tone generation and analysis	Yes		
Load impedance analysis	Yes		
Real Time Analyzer (RTA), 3rd party integration	Yes		
Dante Audio Network			
Dante I/O	8 X 8 (shared with AES67)		
Network topology / redundancy	Flexible topology / Supports daisy-chained and Dual redundant networks		
Sample rates / transport	48, 96 kHz / Uni + Multicast		
Network latency	0.25, 0.5, 1.0, 2.0, 5.0 ms		
AES67 Audio Network			
I/O	8 X 8 (shared with Dante)		
Network topology / redundancy	Flexible topology / Supports daisy-chained		
Sample rates / transport	48 kHz / Multicast		
Network latency	2 ms		
Device Presets			
Local memory locations for the settings of the product	100		
AES Inputs			
Inputs	4 AES inputs		
Supported sample rates/ resolution	44.1, 48, 88.2, 96, 176.4, 192 kHz / up to 24 bits		
Sample rate conversion THD + N 20 Hz - 20 kHz unweighted	0.00003 %		
Analog Inputs			
Inputs	4 high quality inputs with Iso-Float™ ground isolation		
Maximum input / digital reference	+ 26 dBu / +21 dBu		
Sampling rate / resolution	96 kHz / 24 bit		
Input impedance balanced / unbalanced	20 k / 10 k ohm		
THD + N (typical at 1 kHz unweighted)	0.00022 %		
THD + N (typical at 20 Hz and 20 kHz unweighted)	0.00033 %		
Limiters			
Adjustable Inter-Sample Voltage Peak Limiter (ISVPL)	17.8 - 150 V, step size 0.1 V	17.8 - 194 V, step size 0.1 V	17.8 - 194 V, step size 0.1 V
Current Peak Limiter < 300 ms	30 A peak	67 A peak	67 A peak
Current Average Limiter (CAL) > 300 ms	15 Arms	33 Arms	33 Arms
LimiterMax (rms and peak limiters)			
MaxRMS (rms voltage limiter)	Yes		
MaxPeak (peak voltage limiter)	Yes		

15. Technical Specifications

	PLM 5K44	PLM 12K44	PLM 20K44
Amplifier gain	22 - 44 dB, step size 0.1 dB		
Digital attenuator	- Inf to 0 dB, step size 0.25 dB		
Rear-panel interface			
Analog inputs	4 x 3 pin XLR, electronically balanced		
AES inputs	2 x 3 pin XLR		
Output connectors	Neutrik speakON (4 x NLT4) and 4 binding posts (pairs)	Neutrik speakON (1 x NLT8, 2 x NLT4) or 4 binding posts (pairs)	
Auto 100/1000, Auto Uplink	2 x RJ45 etherCON		
Control and monitoring interface	Via Ethernet for Lake Controller software, or DLM (the 3rd party protocol)		
Detachable mains cord	Detachable locking 3-pin IEC rated at 250 V / 16A	Neutrik powerCON 32 A	Neutrik powerCON 32 A
Cooling	Four fans front-to-rear airflow temperature controlled speed	Three fans front-to-rear airflow, temperature controlled speed	
Front-panel interface			
Display	2.5 inch, Black / white, daylight readable LCD		
Fault / Warning / Limit / Clip indicators	RGB LEDs and detailed fault description on display		
Mute and soft function buttons	8 provided		
Standby Power button	On / Standby		
Mute Enable button	Enables muting of outputs and inputs via soft-button keypad		
Meter button	Toggles through meter views		
Menu button	Provides a menu driven interface for full function front panel control		
Rotary Encoder	Yes		
Exit button	Provides a "back" function		
Mains power			
Nominal voltage	100 - 240 V AC 50- 60 Hz	100 - 240 V AC 45- 66 Hz	100 - 240 V AC 45- 66 Hz
Operating voltage	70 - 265 V AC		
Mains wall plug	Selectable order CEE 7/7 "Schuko" 230 V / 16 A, NEMA 5-15 125 V / 15 A, BS1363-A 250 V / 13 A, IA16A3 250 V / 16 A, AU/NZ 250 V / 10 A, JP 125 V / 15 A, CPCS-CCC 250 V / 10 A	NEMA L5-30 "Twist lock" 125 V / 30 A, and CEE 7/7 "Schuko" 230 V / 16 A	NEMA L5-30 "Twist lock" 125 V / 30 A, and CEE 7/7 "Schuko" 230 V / 16 A
Power supply features			
Soft start / Inrush power	Yes		
Power Factor Correction (PFC)	>0.98 for mains power > 300 W	>0.98 for mains power > 400 W	
Regulated switch mode power supply	Yes		
Breaker Emulation Limiter (BEL)	Configurable current threshold and breaker profile		
BEL max current threshold	15 A	25 A	32 A
Power Average Limiter (PAL)	Yes		
Under Voltage Limiter (UVL)	Yes		
Mains under voltage and overvoltage protection and mains glitch tolerance	Yes		
Dimensions			
Rack rail to rear panel	W: 483 mm (19"), H: 88 mm (2 U), D: 424 mm (16.7")		
Overall depth including handles and rear support	D: 498 mm (19.6")		
Weight	11.4 kg (25,1 lbs)	16.5 kg (36 lbs)	17 kg (37 lbs)
Finish	Black painted steel chassis with black painted steel / aluminium front		
Approvals	CE, ANSI / UL 60065 (ETL), CSA C22.2 NO. 60065, PSE, RCM, FCC and CCC	CE, ANSI / UL 60065 (ETL), CSA C22.2 NO. 60065, PSE, RCM, FCC and BIS India	

Note 1): Lab.gruppen burst power (1 kHz, 25 ms burst power @ 150 BPM, 12 dB Crest factor)

All specifications are subject to change without notice.

Intercooler, Class TD and Lake are national and/or international registered trademarks of Lab.gruppen AB. PLM, Powered Loudspeaker Management, R.SMPS, LoadLibrary, LoadSmart, SpeakerSafe, BEL, UVL and ISVPL are trademarks of Lab.gruppen AB. Dolby and the double-D symbol are registered trademarks of Dolby Laboratories. Contour, Mesa Quad EQ, Mesa Parametric EQ, Raised Cosine Equalization, LimiterMax and Iso-Float are trademarks of Dolby Laboratories. Audinate is a registered trademark of Audinate Pty Ltd. Dante and Zen are trademarks of Audinate Pty Ltd. All other trademarks remain the property of their respective owners.

Copyright © 2018 Tribe Brands Innovation Sweden AB.

All rights reserved.

16. Warranty and support

16.1. General

This product is manufactured by Lab.gruppen, and it is warranted to be free from any defects caused by components or factory workmanship, under normal use and service, for a period of ten (10) years from date of purchase from an authorized Lab.gruppen dealer. If the product fails to perform as specified during the warranty period, Lab.gruppen will undertake to repair, or at its option, replace this product at no charge to its owner, provided the unit is returned undamaged, shipping prepaid, to an authorized service facility or to the factory. This warranty shall be null and void if the product is subjected to: repair work or alteration by a person other than those authorized by us; mechanical damage including shipping accidents; war, civil insurrection, misuse, abuse, operation with incorrect AC voltage; incorrect connections or accessories; operation with faulty associated equipment; or exposure to inclement weather conditions. Damage due to normal wear and tear is not covered by the warranty. Units on which the serial number has been removed or defaced will not be eligible for warranty service. Lab.gruppen shall not be responsible for any incidental or consequential damages. Lab.gruppen's responsibility is limited to the product itself. Lab.gruppen takes no responsibility for any loss due to cancellation of any events, or rent of replacement equipment or costs due to a third party's or customer's loss of profit, or any other indirect cost or losses however incurred. Lab.gruppen reserves the right to make changes or improvements in design or manufacturing without assuming any obligation to change or improve products previously manufactured. This warranty is exclusive, and no other warranty is expressed or implied. This warranty does not affect the customer's statutory rights.

International Warranties

Please contact your supplier or distributor for this information, as rights and disclaimers may vary from country to country.

16.2. Technical assistance and service

16.2.1. International service

If your Lab.gruppen product requires repair, contact your Lab.gruppen dealer or distributor, visit <http://labgruppen.com/support> or contact Lab.gruppen by phone or email to obtain details for the nearest authorized service center.

16.2.2. Factory service

In the event a Lab.gruppen product requires factory service, you may contact Lab.gruppen's service department for return instructions and a Return Authorization number.

Please note for product return:

1. Use the original packing.
2. Include a copy of the sales receipt, your name, return address, phone and fax number, email address and description of the defect.
3. Mark the Return Authorization number on the outside of the packing.

Ship the product prepaid to:

Music Tribe Brands Sweden AB Faktorvägen 1
SE-434 37 Kungsbacka
Sweden
Phone: +46 300 56 28 00

service@labgruppen.com www.labgruppen.com

Notes

Notes

www.kling-freitag.de in cooperation with labgruppen.com